

TM9-1276

WAR DEPARTMENT TECHNICAL MANUAL

CARBINES, CAL. .30, M1, M1A1, M2, and M3



WAR DEPARTMENT • JANUARY 1947

WAR DEPARTMENT TECHNICAL MANUAL
TM 9 - 1276

This manual supersedes TM 9-1276, Ordnance Maintenance, Carbines, Cal. .30, M1 and M1A1, 5 June 1943; TB 9-1276-1, 15 January 1945; TB ORD 9, 10 January 1944; and TB 23-7-4, 13 October 1944.

CARBINES, CAL. .30,
M1, M1A1, M2, and M3



WAR DEPARTMENT • JANUARY 1947

United States Government Printing
January : 1947

WAR DEPARTMENT

Washington 25, D. C, 22 January 1947

TM 9-1276, Carbines, Cal. .30, M1, M1A1, M2, and M3, is published for the information and guidance of all concerned.

The material in this manual is correct as of 16 October 1946.
[AG 300.5 (15 Feb 45)].

BY ORDER OF THE SECRETARY OF WAR:

OFFICIAL:

EDWARD F. WITSELL
Major General
The Adjutant General

DWIGHT D. EISENHOWER,
Chief of Staff

DISTRIBUTION :

AAF (5); AGF (2); T (10); Dept (5); AAF Maj Comds (2);
Arm & Sv Bd (1); Tech Sv (2); FC (1); BU (1) PE, Ord 0
(5); Dist 9 (3); Establishments 9 (3) except Am Establish-
ments (0); Gen & Sp Sv Sch (5); A (ZI) (10), (Oversea) (3);
CHQ (2); D (2); AF (3); One (1) copy to each of the following
T/O & E's: 9-7; 9-8; 9-9; 9-12; 9-57; 9-65; 9-67; 9-76; 9-315;
9-318; 9-319; 9-377; 9-417.

For explanation of distribution formula, see FM 21-6.

CONTENTS

	<i>Paragraphs</i>	<i>Page</i>
Section I. INTRODUCTION	1-7	1
II. INSPECTION PRIOR TO DISASSEMBLY	8-17	10
III. TOOLS, GAUGES, AND FIXTURES	18-19	20
IV. GENERAL MAINTENANCE	20-29	27
V. TRIGGER HOUSING GROUP	30-34	42
VI. OPERATING SLIDE ASSEMBLY	35-37	52
VII. BOLT GROUP	38-41	55
VIII. FRONT SIGHT ASSEMBLY	42-45	58
IX. REAR SIGHT ASSEMBLY	46-49	61
X. BARREL AND RECEIVER GROUP	50-53	70
XI. STOCK GROUP	54-57	83
XII. MAGAZINE ASSEMBLY	58-60	95
XIII. EQUIPMENT	61-64	99
XIV. FUNCTION FIRING AND FINAL INSPECTION	65-67	101
APPENDIX		104

This manual supersedes TM 9-1276, Ordnance Maintenance, Carbines, Cal. .30, M1 and M1A1, 5 June 1943; TB 9-1276-1, 15 January 1945; TB ORD 9, 10 January 1944; and TB 23-7-4, 13 October 1944.

SECTION I

INTRODUCTION

1. Scope

This manual is published for the information and guidance of ordnance maintenance personnel. It contains detailed instructions for inspection, disassembly, assembly, maintenance, and repair of the carbines, cal. .30, M1, M1A1, M2 and M3. This manual does not contain general assembly or disassembly or information which is intended primarily for the using arms. For such information see FM 23-7.

2. Characteristics

The carbines, cal. .30, M1 and M1A1 are gas-operated self-loading, air-cooled shoulder weapons delivering semiautomatic fire and are fed by a 15-round box-type magazine. The carbines, cal. .30, M2 and M3 deliver either semiautomatic or full automatic fire controlled by the operator through the use of a selector and are fed by a 30-round box type magazine. The 15-round and 30-round magazines can be used interchangeably among the various models.

3. Difference Between Models

a. CARBINE CAL. .30, M1 (fig. 1). This model is the basic carbine. It has a one-piece wooden stock and a hand guard. One end of a sling is attached to a swivel fastened to the front band which retains the stock and hand guard; the other end is looped around an oiler, which is inserted into the right side of the rear end of the stock. The front sight is of the blade type fastened to the muzzle end of the barrel. The rear sight is the adjustable type, either D73955 (machined type) or D7160060 (stamped type). The two sights differ only in method of manufacture.

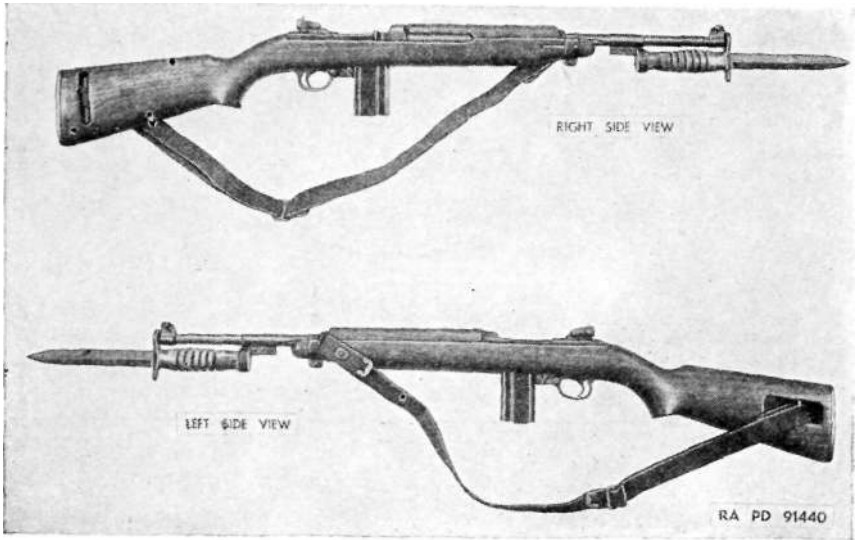

Figure 1. Carbine, cal. .30 M1.

b. CARBINE, CAL. .30, M1A1 (fig. 2). This model is identical with the carbine M1 with the exception of the stock. A separate grip is attached to the stock of the carbine M1A1 and a metal skeleton folding stock extension is hinged to the grip and to the rear end of the stock. The sling is attached to the sling swivel on the front band and to a slot in the lower hinge assembly on the grip.

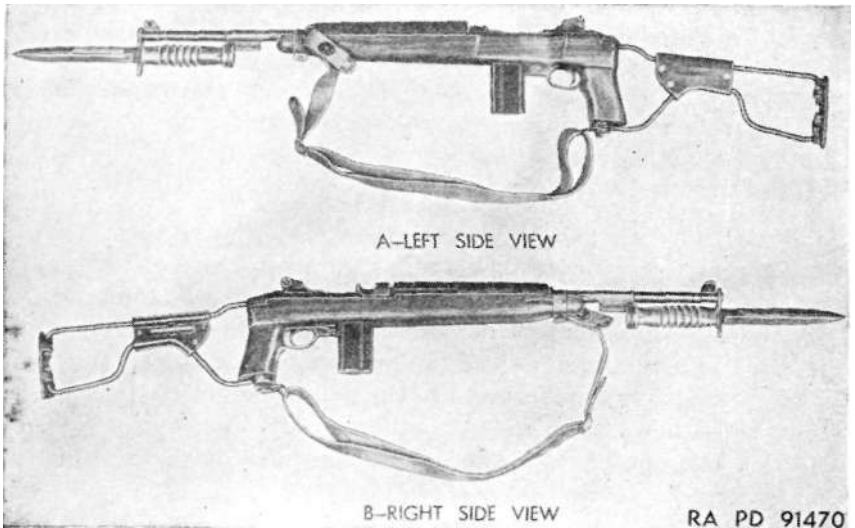

Figure 2. Carbine, cal. .30, M1A1.

c. CARBINE, CAL. .30, M2 (fig. 3). (1) This model is almost identical with the carbine, cal. .30, M1, except for a number of parts which have been modified, redesigned, or added, to produce a carbine which can be fired either in semiautomatic or fullautomatic position, through the use of the selector. When fired in fullautomatic, the rate of fire is

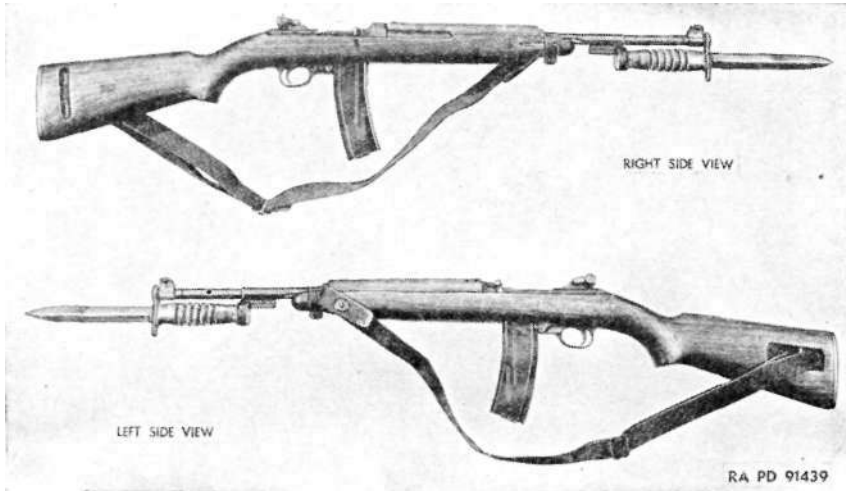

Figure 3. Carbine, cal. .30, M2.

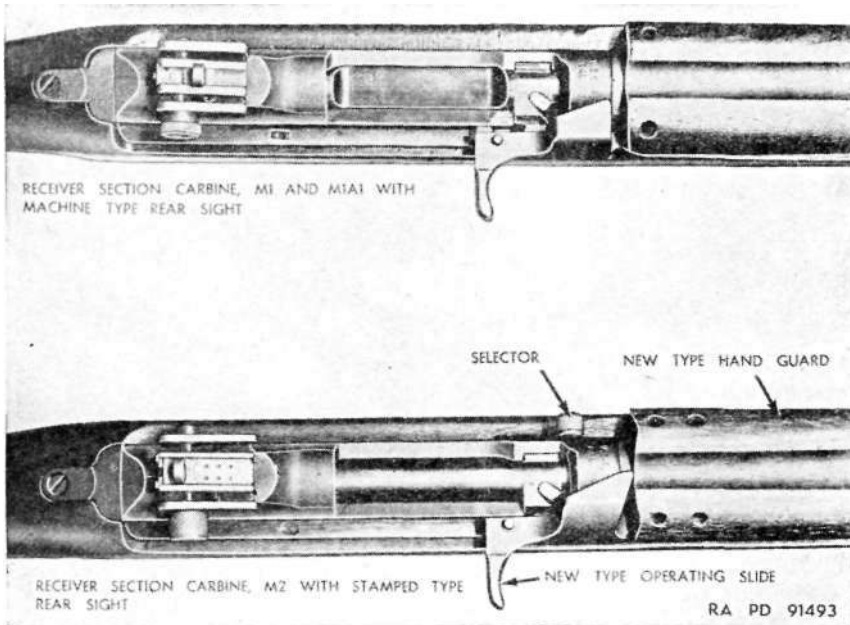

Figure 4. Receiver sections — Variations among models.

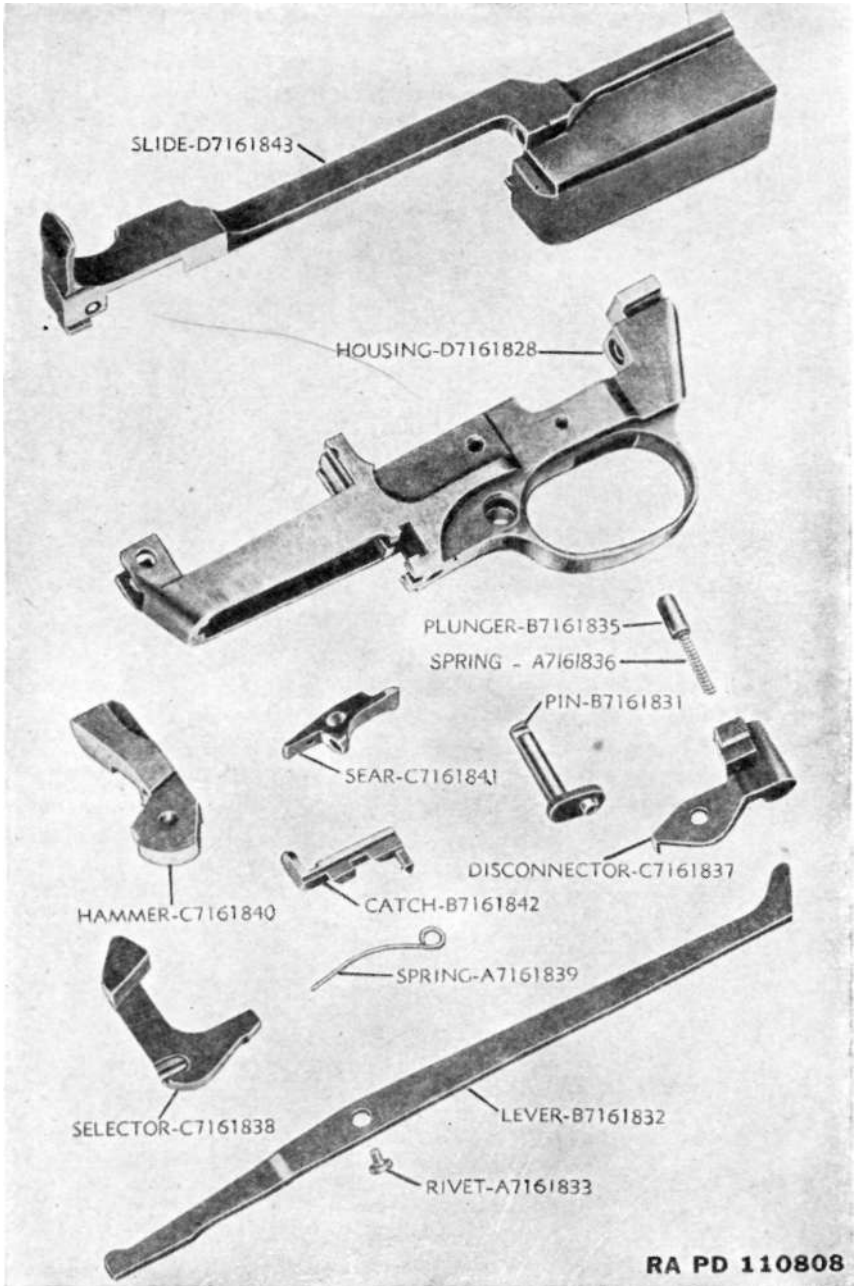

Figure 5. Operating group parts changed and added for use on carbines cal. .30 M2 and M3.

approximately 750 to 775 rounds per minute. The M2 carbine can be identified by the selector (fig. 4), which projects from the left side of the receiver opposite the operating slide handle.

(2) Description of changed parts and their relative functioning are as follows (fig. 5):

(a) *Hammer*. Same as the M1 hammer, except that it has a milled cut in the lower right side to furnish clearance for the disconnector when assembled on the hammer pin.

(b) *Sear*. Same as the M1 sear, except for a raised shoulder on the top of the front end, which forms a camming surface for the disconnector when operated.

(c) *Trigger housing*. Same as the M1, except that the left side of the magazine post is furnished with a retention slot, and the front face with a dismounting notch for the selector spring. (The dismounting notch leads into the top of the slot.) The right side has a milled cut for clearance of the disconnector lever.

(d) *Operating slide*. Same as the M1, except for a clearance cut extending along the right-hand side of the body, and a diagonal cut at the point where the shank of the handle joins the body. The latter cut forms a cam for camming down the forward end of the disconnector lever.

(e) *Magazine catch*. The redesigned M1 magazine catch for the M2 has an added projection on the left end, facing forward, to act as an additional support for the 30-round magazine. This magazine catch may also be used on M1 and M1A1 carbines.

(f) *Stock*. A clearance cut was made in the inner right wall for clearance for the projecting right side of the disconnector. A cut was also made in the inner left wall for clearance for the selector. The bridge was cut down to the central section for clearance for the disconnector lever.

(g) *Disconnector group — added parts*. The disconnector pivots on the hammer pin when assembled. The rear end has a lateral projection, which bears upon the raised shoulder of the sear, when the disconnector is cam-operated by the disconnector lever for fullautomatic fire. The forward end has a projecting lug on the right side, which lies outside the trigger housing and engages and acts as a camming surface for the rear end of the disconnector lever. A spring and a plunger bearing on the receiver return the disconnector to the inoperative position, when the camming action of the lever is discontinued.

(h) *Disconnector lever assembly — added parts*. The disconnector lever assembly is composed of a trigger housing selector pin, disconnector lever rivet, and disconnector lever. Do not disassemble it. The pin retains the trigger housing when assembled to the receiver. The disconnector lever, riveted to a pivot on the pin, is shifted vertically, by the turning of the pin. The pin is turned by the selector. A rounded projection on the rear end of the disconnector lever operates the dis-

connector. A projecting toe at the front end of the disconnecter lever contacts the camming surface on the operating slide. An offset in the rear section provides for alignment with the slot in the disconnecter.

(i) *Selector group — added part.* The selector is mounted to the left end of the crank pin by means of a slot in the lower forward face of the selector mating with straddle slots in the end of the pin. The selector holds the pin in position and acts as a lever for turning, throwing the disconnecter lever into or out of engagement with the operating slide. A curved wire spring holds the selector in position on the pin, and in the fullautomatic or semiautomatic position when operated. The straight front end of the spring seats into a recess in the lower rear end of the selector, and the circular rear end of the spring seats in a vertical slot in the front face of the magazine post on the left side. When assembled, the bow of the spring faces upward.

d. CARBINE, CAL. .30, M3. This model is identical with the carbine, cal. .30, M2 except that the top of the receiver is designed to accommodate special sighting equipment (sniperscope) issued by the Corps of Engineers. Information on the Sniperscope may be found in TM 5-9341. There are no provisions made in this receiver for the conventional rear sight.

4. Description of Adjustable Rear Sight Assemblies

The rear sight assembly D73955 (machined type) or D7160060 (stamped type) differ only in method of manufacture. (See fig. 6.) The assembly

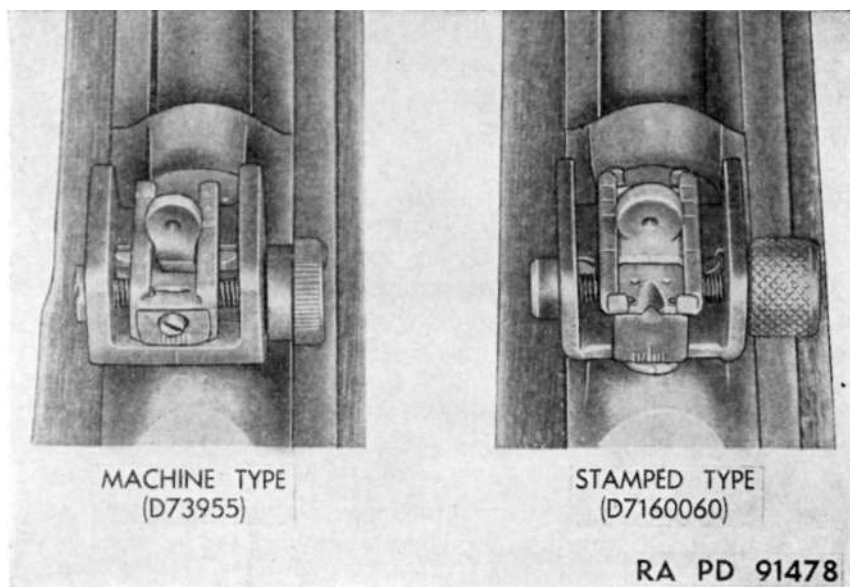

Figure 6. Rear sight — machined and stamped types.

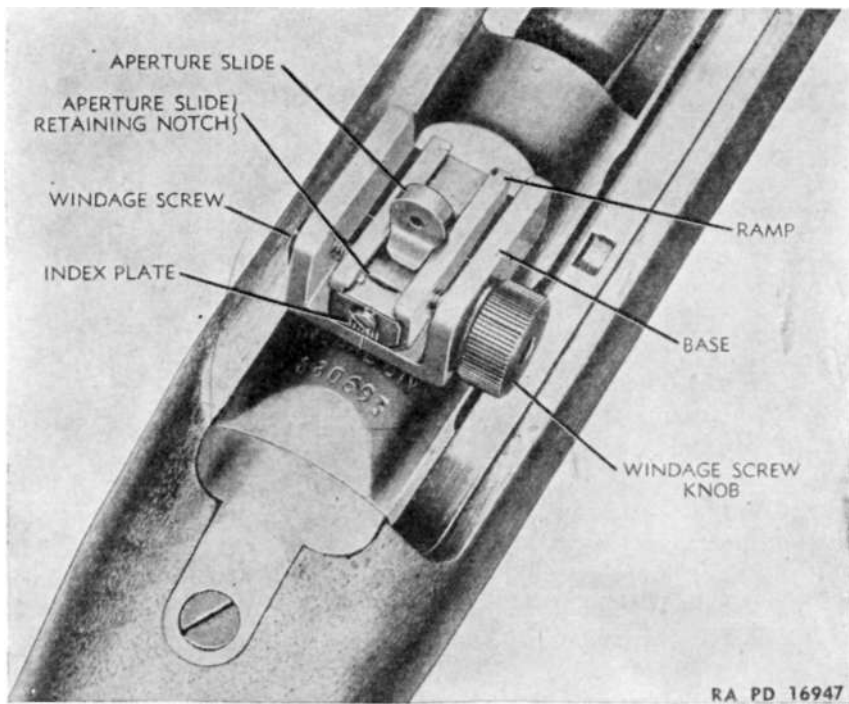

Figure 7. Adjustable rear sight assembly — Machined type.

is composed of a wing type base, which is assembled to the bridge of the receiver from the right-hand side of the carbine by means of a dovetailed lug on the bottom of the base. (See fig. 7.) The lug slides into a dovetailed slot in the top rear of the receiver. The dovetail tapers slightly from right to left, tending to provide a tighter fit as the base is advanced. The base is held in place, when aligned, by staking the rear edge of the mounting slot in the receiver into two notches in the front edge of the dovetailed lug on the sight base.

5. Description of Cartridge

A cal. .30 cartridge is used with this carbine. It differs from the cal. .30 cartridge used in rifles and machine guns of same caliber in that the bullet is smaller and the casing shorter and smaller and without a neck. (See fig. 8.) Ballistics are included in data in paragraph 6.

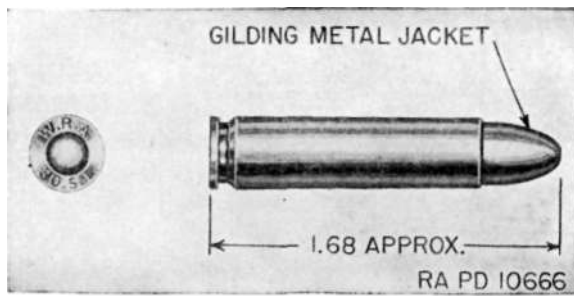

Figure 8. Cartridge, carbine, cal. .30 M1.

6. Data

Weight of carbines M1 and M2, with 15-round magazine (unloaded)	5.50 lb
Weight of carbine, M1A1, with 15-round magazine (unloaded)	6.19 lb
Weight of carbines, M1 and M2 with 15-round magazine (loaded) and sling	6.10 lb
Weight of carbine, M1A1 with 15-round magazine (loaded) and sling	6.79 lb
Weight of carbine, M2 with 30-round magazine (unloaded)	5.53 lb
Weight of carbine, M2 with 30-round magazine (loaded)660 lb
Magazine capacity (old type)	15 rounds
Magazine capacity (new type)	30 rounds
Weight of 15-round magazine (unloaded)	0.17 lb
Weight of 15-round magazine (loaded)	0.59 lb
Weight of 30-round magazine (unloaded)	0.2 lb
Weight of 30-round magazine (loaded)11 lb
Over-all length of carbine M1 and M2	35.58 in.
Over-all length of carbine M1A1 (stock extension extended)	35.63 in.
Over-all length of carbine M1A1 (stock extension folded)	25.51 in.
Over-all length of carbine M1 and M2 with bayonet attached	42.26 in.
Over-all length of carbine M1A1 with bayonet attached (stock extended)	42.31 in.
Weight of 100 cartridges	2.75 lb
Weight of 1 ball cartridge	193 grains
Weight of bullet (approximate)	111 grains
Muzzle velocity	2,000 ft per sec
Pressure in chamber per square inch maximum (approximate)	40,000 lb

Maximum range.....	2,000 yd
Effective range.....	300 yd
Rate of fire, fullautomatic (M2).....	750-775 rounds per min
Length of barrel.....	18.00 in.
Rifling:	
Length.....	16.77 in.
Number of grooves.....	4
Twist (direction).....	right hand
Twist.....	1 turn in 20.00 in.
Sight radius at 100 yards.....	21.5 in.
Trigger pull.....	5-7 lb
Shipping weight of arms chest containing 10	
carbines M1 and M2.....	83.00 lb
Shipping weight of arms chest containing 10	
carbines M1A1.....	91.00 lb
Dimensions of arms chest (outside)...	$39\frac{3}{8} \times 10\frac{3}{4} \times 10\frac{3}{4}$ in.
Cubical displacement of arms chest.....	4.00 cu ft
Ballistics of cartridge.....	(FM 23-7)

Note. 7,000 grains equal 1 pound avoirdupois measure.

7. Forms and Records

Ordnance inspection records provide a written record of the status as regards serviceability of ordnance materiel in the hands of troops. These records must be maintained at all times.

SECTION II

INSPECTION PRIOR TO DISASSEMBLY

8. General

This section covers specific instructions for inspection by ordnance personnel of the materiel in the hands of troops, as well as inspection of the materiel undergoing repair in ordnance shops. The inspector should be well versed in maintenance procedure for the materiel and must have a working knowledge of the tools needed for its inspection.

9. Purpose

a. Fundamentally, inspection is made for the purpose of determining whether materiel is serviceable and dependable, and the extent of its serviceability. Serviceability, as interpreted in this section, is the ability of the carbine to perform completely its intended functions.

b. If the carbine is found unserviceable, determine the cause and extent of unserviceability. If practical, correct on the spot deficiencies in weapons in the hands of troops. If the carbine is being overhauled by an ordnance shop, inspect thoroughly and completely, put into the best possible condition that time, materials, and tactical circumstances will allow, and return to the using arm ready for use. (See serviceability chart, fig. 19.)

10. Reports

a. Forward suggested improvements in design, maintenance, safety and efficiency of operation prompted by chronic failure or malfunction of the weapon, spare parts, accessories or equipment, to the office of the Chief of Ordnance, Field Service, Maintenance Division, Washington 25, D. C, with all available pertinent information necessary to initiate corrective action. Report this information on WD AGO Form 468. (Unsatisfactory Equipment Report). If WD AGO Form 468 is not available, refer to TM 37-250 for list of data required on Unsatisfactory Equipment Report.

b. Report to the responsible officer any pertinent carelessness or negligence in the observance of preventive maintenance procedures

and safety precautions. Accompany this report with recommendations for correcting the unsatisfactory conditions.

Note. The inspector's aim is not to be critical of the using troops, but to be helpful.

11. Inspection — General Condition, Operation, and Functioning

Caution: Hold each carbine with the muzzle pointed at the floor, clear at once, and inspect the chamber for a live round. See that there are no obstructions in bore or chamber. Do not touch trigger until after carbine has been cleared.

a. Before inspection is begun, clean the materiel thoroughly to remove any grease, dirt, or other foreign matter which might interfere with its proper functioning, or the use of the gauges and tools used in inspection.

b. Inspection, maintenance, and repair of the carbine should be thorough and exacting, for the malfunction of one small part may cause malfunction of the carbine.

c. Inspect the carbine visually for general condition, operation, and functioning before disassembling for detailed inspection. Use dummy cartridges, if available.

d. Inspect carbine for appearance and general condition as follows:

(1) Inspect barrel and receiver group for looseness in stock, and hand guard for excessive looseness on stock. Hand guard may have slight movement backward and forward. However, there should be no possibility of its becoming disengaged from the front band or skirt on the receiver. Tight hand guards are likely to push band off when recoil is heavy, as when grenade launcher is used.

(2) Inspect front band for looseness and locking on carbine and inspect sling swivel for looseness on band. Band should be held firmly in place by shoulder of locking spring.

(3) Inspect stock and hand guard for cracks, undue scarring, and dried out wood; check grip (M1A1) for looseness on stock and for cracks.

(4) Inspect front and rear sights for looseness.

(5) Inspect oiler for retention in stock, and sling for wear and security on carbine.

(6) Inspect metal parts for rust, corrosion, scoring, and cracks.

(7) Inspect magazine for retention in receiver, ease of withdrawal, undue looseness, dents, rust, and movement of follower.

(8) Inspect sling eyelet for looseness on lower hinge assembly (M1A1), and hinge for looseness on stock grip.

(9) Inspect stock extension (M1A1) for hinge action, and positive locking when extended and folded, and butt plate for rotation and spring action on bars.

(10) Inspect cheek rest plate and retaining plate (M1A1) for

looseness on bars, and cheek rest plate cover for wrinkles, scoring, and dried out leather.

(11) Inspect barrel.

e. With dummy cartridges in the magazine, retract and release the operating slide, to load and eject the dummy cartridges. During the operation, inspect the following points:

(1) *Smooth functioning of operating slide and bolt.* They should reciprocate smoothly and easily, without undue looseness.

(2) *Complete locking of bolt, and forward movement of operating slide.* The slide should continue to move forward about $\frac{5}{16}$ inch after the bolt is fully locked. The same free movement should take place at the start of the rearward movement of the slide, before rotation of the bolt begins.

(3) *Grip of extractor on cartridge and function of ejector.* Extractor should grip base of cartridge firmly and ejector should throw it off the bolt as soon as front end of cartridge is clear of the receiver. If cartridge is not extracted the extractor claw may be damaged, or extractor plunger or spring broken or missing. Failure to eject may be caused by a broken ejector or a weak or broken ejector spring. If dummy cartridges are not available, operate parts individually, and test spring action.

(4) *Chambering of cartridge.* The bolt should chamber the cartridge smoothly when released. If bullet ramp on receiver or barrel is rough, or magazine loose so that it tips forward, the bullet may bind on ramp or be deflected upward during chambering and strike the top of the barrel and cause a stoppage.

(5) *Position of cartridge in mouth of magazine.* If magazine follower does not position cartridge fully up against lips of magazine, the magazine spring may be weak or broken, or the tube or follower dented, rusted, or burred, or the magazine incorrectly assembled. If dummy cartridges are not available, depress follower to bottom of tube and then allow it to rise. Inspect for smooth and positive functioning.

(6) *Engagement of sear with hammer.* The sear should engage with sear notch in hammer when bolt is about halfway retracted. A crisp click may be heard as sear slides forward into the sear notch in hammer under force of sear spring. Retract the bolt fully to insure complete engagement and retention of sear. If click is not heard or trigger pull appears to be light or excessively heavy, examine sear and sear notch in hammer for wear, burs, foreign matter in sear notch, or weak or broken sear spring. Trigger pull should not be under 5 pounds or over 7 pounds. (See par. 13b.)

(7) *Engagement of sear when trigger is not released.* The sear should engage and hold the hammer when the trigger is held back and the slide operated rapidly. Test by grasping the carbine by the grip of the stock with the left hand with index finger on the trigger. Pull the trigger all the way to the rear and hold in that position. Grasp the operating slide handle with the right hand and move the bolt back and

forth rapidly five or six times. Release the operating slide handle in the forward position, release the trigger, allowing it to move fully forward, and then pull it again. If the hammer does not fall, it has jarred out of engagement with the sear and followed the bolt forward. If this is the case, the carbine may fire fullautomatic and the firing mechanism should be inspected for worn or faulty parts.

(8) *Carbines with automatic tendencies.* Carbines with automatic tendencies can be detected by extremely light or short pulls on the trigger. If, during firing, the trigger is held back fully during cocking and the bolt allowed to return to battery before releasing the trigger, tendency to automatic is detected by releasing the trigger very slowly until the sear is heard to snap. On "automatic" carbines the hammer will often fall at this point, or shock of counterrecoil will jar it off.

f. Inspect functioning of the parts given below as indicated.

(1) *Bolt.* With operating slide assembled to bolt, and spring and guide disassembled from slide, reciprocate bolt both slowly and rapidly by means of the operating slide handle. The bolt and slide should move freely in their guideways. The bolt will check slightly as it rides over the hammer on its rearward movement. If binding of bolt and slide is apparent, disengage slide from bolt and function individually to ascertain point of binding. Burs may occur in bolt or operating slide guideways, on bolt or operating slide. The cocking cam on hammer and bolt, or the tang of the firing pin and its mating cam in receiver may be burred. Remove such burs by stoning to a polish, with a fine grained sharpening stone.

(2) *Trigger.* Trigger should move forward under force of trigger spring when released from rearward position. If trigger does not move forward positively, trigger spring may be broken, disengaged, or bent. Trigger hang is also caused by old type triggers with the 4° angle on the forward face of the pedestal. Test trigger pull as explained in paragraph 13.

(3) *Safety.* The safety should slide without undue interference. It should block trigger when pushed fully to right and release trigger when pushed fully to left and it should be positively retained in either position. (See par. 33*f*.)

(4) *Magazine catch.* The magazine catch should return to position when released after it is pressed to the left to disengage magazine. If action is sluggish, examine for burs, foreign matter, broken spring, lack of lubrication, or damaged retainer plunger or spring.

(5) *Front band (narrow and wide type).* The front band should be lying securely behind shoulder of locking spring when screw is drawn down snugly and locking spring engaged positively. If spring will not depress, inspect for foreign matter in seating recess in stock. If spring does not engage positively with front band, check for bent spring or worn or burred locking shoulder (fig. 9), or excessive wood on stock or hand guard. (See par. 56*c*.)

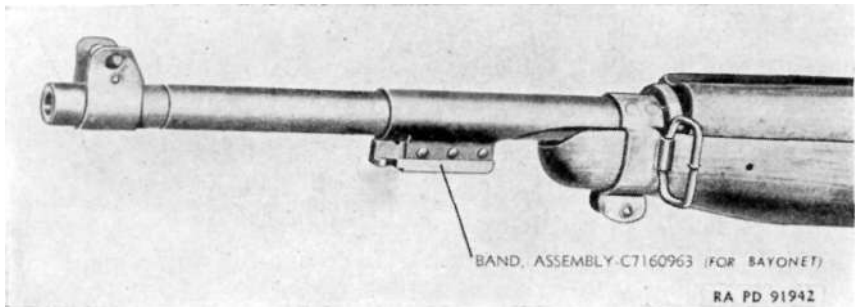

Figure 9. Front band assembly for bayonet.

(6) *Front band (wide type welded to sleeve assembly).* Inspect band as in step (5) above. Check for looseness of rivets. Using a serviceable bayonet knife, M4 check bayonet lug for retention.

(7) *Rear sight.* Inspect sight assembly generally for rust, dents, burs, and foreign matter, looseness of moving parts, and looseness of assembly on the carbine. The sight base should be tight in the receiver. There should be no unnecessary play in the moving parts of the assembly.

(8) *Recoil plate and receiver locking lug.* The recoil plate should be snugly seated in its retaining recess by the screw. Looseness of recoil plate in stock, or receiver locking lug in undercut in plate, will cause barrel and receiver group to become loose. Peen down burs arising from improper assembling of lug in plate, before stoning in order not to reduce metal on lug. Mating of receiver locking lug with recoil plate may be tightened as described in paragraph 57b. Recoil plates of recent manufacture are designed to apply spring tension between the parts.

(9) *Operating slide spring and guide.* The operating slide spring and guide should work freely in well in receiver or housing tube. If binding is apparent, look for bent guide, kinked spring, foreign matter in well, or bent housing tube. Check parallelism of barrel and receiver as explained in paragraph 52c (3). (For variations in housing of spring, see par. 35e).

(10) *Operating slide.* Operating slide rear guide lug should not become disengaged from receiver when reciprocated unless undue upward pressure is applied. If this happens, look for bent bar or excessively worn retaining lugs on operating slide body.

(11) *Operating slide stop.* The operating slide stop is for the purpose of "hanging" the slide and bolt in the retracted position. Test functioning of stop by retracting bolt with operating slide, spring, and guide assembled, and pressing stop into retaining notch in receiver. When "hung" slide is slightly retracted, the stop should be cammed out of retaining notch in receiver and lie flush with lower face of slide, and be held in this position by the friction spring. If stop spring be-

comes broken, stop may catch in retaining notch when slide reciprocates. If nose of stop or edge of retaining notch becomes worn, or friction spring becomes weak or broken, stop is likely to slip and fail to bang bolt. If there is insufficient friction on stop, it may jar into the notch and "hang" the bolt when the carbine functions. If such is the case, replace stop or spring or send carbine to base shop or arsenal for repair.

12. Operating Inspection, Carbines, cal. .30, M2 and M3

With carbine fully assembled and *unloaded* and safety pushed to left fire position, test for functioning as follows:

a. Pull selector fully to rear to place mechanism in the semiautomatic position. Then, with trigger released, fully retract bolt to cock the hammer, and allow bolt to spring forward. Hammer should not fall, until trigger is pulled.

b. With trigger held back, cock the hammer as above and allow bolt to spring forward. Hammer should not fall until trigger is released and then pulled.

c. With trigger released, retract bolt to cock hammer, and allow bolt to spring forward. Push selector forward to place mechanism in full automatic position. Hammer should not fall until trigger is pulled.

d. With selector still forward, and trigger held back, retract bolt to cock hammer, then ease bolt forward slowly. The hammer should not fall until the bolt is fully locked. The hammer can distinctly be heard striking the firing pin.

e. Test safety with selector in both positions. It should not be possible to release the hammer with safety pushed to right.

Note. If the trigger is not released during firing, and the selector is pushed forward to the full automatic position, the hammer will fall. Trigger should always be released when shifting from semiautomatic to full automatic fire or vice versa.

13. Trigger Pull

a. GENERAL. (1) Test trigger pull for smoothness and for pressure exerted. Trigger pull should be clean, without creep, smooth in action; and the force exerted to release hammer should be more than 5 pounds and less than 7 pounds (See *b* below.) If pull is rough, or not within specified limits, or creep is present, it indicates that there is wear or burs on sear nose, hammer notch, or top of trigger lip, or interference between trigger and housing.

Note. The word "creep" is interpreted to mean any perceptible movement in the trigger pull between the time the slack is taken up and the hammer is released, with pressure applied to the trigger at a uniform rate of increase over a period of 10 seconds or more.

(2) The inspector, in testing trigger pull of carbines in the hands of troops, should have hooks and weights, which will combine to 5 and 7 pounds.

b. TESTING TRIGGER PULL (fig. 10). Note that safety is disengaged and pushed all the way to the left, and that carbine is cocked. Have the weights resting on the floor or ground, and insert the hook of trigger weight wire through the trigger housing guard bow to bear on the trigger so that pressure is applied $\frac{1}{4}$ inch from lower end or tip of trigger. With the barrel of the carbine held vertically, raise the weight from the floor as gently as possible. If 5-pound weight pulls the trigger to release the hammer, or the 7-pound weight fails to pull the trigger to release the hammer, correct the carbine or forward to a base shop or arsenal for correction. (See par. 33d.) The only correction allowed in field repair is the selective assembly of hammer, hammer spring, sear, and/or trigger or all four until the required pull is obtained. Take care during the test to see that the wire contacts the trigger only and does not rub against the trigger housing or stock, and that wire and axis of bore are perpendicular to the floor.

Note. Each time weights are applied to the trigger, cock the weapon again, otherwise sear may be *partially* disengaged from hammer. This will result in a false reading next time weights are applied.

14. Barrel and Receiver Group

a. Inspect the barrel visually to determine the condition of the bore. Make a gauge inspection to determine the amount of wear that has taken place in the chamber, or in related parts affecting headspace.

b. Gauge inspection offers no problems, as the tolerances are definitely set; however, classification of barrels by visual inspection is a matter of individual skill and judgment and therefore offers many problems. Care in interpretation and application of the standards contained herein will aid in arriving at a uniform point of rejection. The point at which a barrel is rejected by visual inspection varies with the disposition to be made of the rifle immediately following inspection. The various possibilities are divided into three classes:

(1) *Weapons in hands of troops.* Headspace measurements should be within the limits set by serviceability chart. (See fig. 19.) If the barrel is pitted to the extent that the sharpness of the lands is affected, or if it has a pit or pits in the lands or grooves large enough to permit the passage of gas past the bullet, it is to be scrapped. A pit the width of a land or groove and $\frac{3}{8}$ inch long or longer indicates this condition. Examine barrel for mechanical damage and examine the chamber for deep pits that would seriously affect extraction.

(2) *Weapons to accompany troops overseas.* Headspace measurements are within limits set by the serviceability chart. (See fig. 19.) Examine barrel for pits or mechanical damage. A barrel having fine scattered pits but with sharp edges on the lands may be considered serviceable. Only barrels which show excessive wear, developed pits, or pits cutting the lands are considered unserviceable for oversea shipment.



Figure 10. Testing Trigger pull.

(3) *Weapons to be placed in storage for reissue.* Headspace measurements are within limits set by the serviceability chart. (See fig. 19.) A few fine pits are acceptable. However, the general appearance of the bore should approximate that of a new barrel and should appear to have a minimum of 75 percent of its normal life left.

15. Headspace Gauging

a. The headspace of a carbine is the distance between the shoulder of the chamber and the face of the bolt when the bolt is in locked position. If headspace is insufficient, the bolt will not fully lock behind the cartridge without being forced. If headspace is excessive, the cartridge will have too much play in the chamber when the bolt is locked be-

hind it. Either condition is unsafe. As component parts of the carbine are manufactured to close tolerances and headspace is carefully checked at manufacture, a variation usually is due to wear and causes excessive headspace to develop. However, assembly of parts with maximum tolerances may result in either excessive or insufficient headspace.

b. Excessive headspace due to wear may be caused by advanced chamber shoulder, worn faces of bolt, worn locking lugs on bolt, or worn locking shoulders in the receiver.

c. Test headspace with gauge (fig: 54), as follows:

(1) Clean bore, chamber of barrel, and operating parts thoroughly, wipe dry, and inspect for metal fouling or foreign matter. Operate the mechanism a few times to see that bolt closes and locks smoothly on an empty chamber.

(2) Retract and hang the bolt by means of the slide stop. Place the headspace gauge on the face of the bolt, gripped by the extractor. Be sure that gauge is perfectly clean and dry.

(3) Retract the bolt slightly to disengage the operating slide stop, and allow the bolt to move slowly forward to the locked position so the gauge enters the chamber of the barrel. If the bolt locks fully on the maximum gauge, the headspace is excessive and the carbine un-serviceable. Lock the bolt completely when the minimum gauge is used.

Caution: Do not force, or allow bolt to close sharply under spring propulsion.

(4) Pull back bolt and remove gauge.

Note. See serviceability chart (fig. 19) for proper headspace gauge. Forward headspace gauges to an arsenal once a year for checking.

16. Magazine

Test magazine for retention in carbine. Inspect follower for smooth movement in tube under force of spring by depressing follower and allowing it to rise. If follower does not depress and rise smoothly to the top of tube under spring action, look for burs, rust, and corrosion in tube, reversed follower, deformed, or burred tube or follower, and weak, broken, or reversed spring. Apply pressure evenly on the follower when depressing in order not to "cock" or rotate it in the tube.

17. Adjustable Rear Sight Assembly

a. Inspect sight assembly generally for rust, dents, burs, and foreign matter, looseness of moving parts, and looseness of assembly on the carbine. The sight base should be tight in receiver. There should be no unnecessary play in the moving parts of the assembly.

b. Check sight base for looseness and bent, burred, or shiny wings. Check ramp for worn or burred guideways and index ball retention

notches in floor. Check notches for foreign matter. Check index plate on rear face of ramp for security and setting.

c. Check windage screw for wear of threads, burs, and looseness, security, and staking. With ramp centered in sight base, press windage screw knob to left and release, to test spring action of index ball on knob. There should be approximately 0.005 inch lateral movement of the knob, due to pressure and index spring action.

d. With ramp centered in sight base, attempt to move lower end of ramp from side to side. There should be practically no lateral movement. If very noticeable movement is present, it indicates worn threads on either windage screw or ramp, or both. Press rear end of ramp down and release, to check spring action of ramp guide plunger.

SECTION III

TOOLS, GAUGES, AND FIXTURES

18. General

a. The special tools and gauges for the inspection, disassembly, assembly, and repair of the carbine, cal. .30, M1, M1A1, and M2 are listed on ORD 6 SNL B-20.

b. Common tools (screw drivers, drifts, pliers, hammers, stones, etc.) which normally are used in maintenance and repair, are standard to maintenance organizations and are listed in appropriate standard nomenclature lists.

c. Return all field service inspection gauges to an arsenal for checking once each year.

19. Special Tools

a. TOOL, DISASSEMBLING, BOLT 41-T-3019-625 (fig. 11). This tool consists of a concave body to receive the bolt. A thumb screw set at an angle applies pressure when tightened, to the right locking lug of the bolt. A small stud on the inside forward end of the tool bears against the ejector, and a pivoted pawl, for depressing the ejector plunger, is on the upper forward portion of the tool.

b. TOOL, REMOVING, TRIGGER SPRING, ASSEMBLY 41-T-3318 (fig. 11). This tool consists of a hollow tube 0.3135 inch diameter with a handle projecting at a 90° angle from the tube.

c. TOOL, ASSEMBLING, FRONT SIGHT 41-T-3017-625 (fig. 12). The front sight assembling tool is a hexagonal shaped driver with the interior drilled which acts as a guide to receive the barrel. A spring loaded plunger protrudes from the front and when the plunger is bottomed it acts as a stop to align the hole for the front sight pin. A cut on the upper front portion of the tool provides a bearing surface for driving on the sight, and also makes it possible to rotate the sight on the barrel for alignment of the key and keyway.

d. TOOL, REMOVING, FRONT SIGHT 41-T-3318-500 (fig. 12). This tool consists of a steel frame slotted on one end to fit over the band to the rear of the front sight. On the other end of the tool is a jack screw with a floating pilot which seats in the muzzle of the barrel.

e. TOOL, GAS CYLINDER RECONDITIONING, COMPLETE 41-T-3164 (fig. 11). (1) The gas cylinder reconditioning tool consists of —

- (a) Holder, tap and spanner wrench, gas cylinder 41-H-2373.
- (b) Tap, gas cylinder, 1/2-32NS3, 41-T-336-900.
- (c) Wrench, spanner, gas cylinder 41-T-3249-725.

(2) It is used to remove and install the gas piston nut and to recondition the threads in the gas cylinder; it is composed of three main parts, a holder, a wrench, and a tap. The holder is designed to be attached to the lug on the bottom of the receiver. Drill a well in the holder to receive the shaft and spring of either the wrench or tap. The wrench and tap are operated by using a steel pin attached to the holder, which serves as a lever when inserted into the wrench or tap.

f. TOOL, ASSEMBLING, ADJUSTABLE REAR SIGHT 41-T-3016-125 (fig. 13). This tool is designed to fit over the receiver, and when properly located, utilizes a jack screw to force the sight into position. A dovetail guide and a locating pin in conjunction with a lip on the lower right-hand side of the tool assures that the tool is positioned correctly. A jack screw and connector serve to remove adjustable rear sights which cannot be installed within the prescribed pressure limits. A spacer, attached to the tool, serves to reinforce the wings of the stamped typed sight when pressure is applied by the jack screw.

g. WRENCH, TORQUE, INDICATING $\frac{1}{4}$ INCH SQUARE DRIVE, 60-INCH POUND 41-W-3628-80 (fig. 13). The torque wrench is used in conjunction with the rear sight assembling tool in order to measure the pressure required to position the adjustable rear sight.

h. PUNCH, STAKING SIZE $\frac{1}{8}$ INCH X 2 INCH, PT. 0.005 41-P-3848-950 (fig. 13). The staking punch is used for staking the receiver to hold the adjustable rear sight in place.

i. FIXTURE, STAKING, ADJUSTABLE REAR SIGHT 41-F-2997-358 (fig. 13). The staking fixture is a template used to locate the points of staking after installing an adjustable rear sight. One end of the fixture is used with the stamped type sight, the other with the machined type sight.

j. WRENCH, RECEIVER AND BARREL, CAL. .30 CARBINE, 41-W-1998-750 (fig. 14). This wrench has a rectangular opening in the side which conforms to the carbine receiver and is used to remove barrels when rebarreling is necessary.

k. WRENCH, RECEIVER AND BARREL, CAL. .30, CARBINE 41-W-1998-765 (fig. 14). This is a special wrench designed to conform to the three sides of the carbine receiver, providing a greater bearing surface than the receiver wrench of early manufacture.

l. REAMER, CARBINE-S., BREECHING SPACE, CARBINE, CAL. .30 COMPLETE 41-R-488-125 (fig. 15). This tool is a reamer connected to a handle by means of a universal joint. The universal joint permits the reamer which is in alignment with the barrel to be rotated by the handle protruding from the receiver at an angle.

m. GAUGE, HEADSPACE, 1.290 41-G-199-175, GAUGE HEADSPACE 1.300 41-G-199-200 (fig. 16). These gauges are used to check the headspace in carbines.

n. GAUGE FIRING PIN PROTRUSION 41-G-194-125 (fig. 16). The firing pin protrusion gauge is a double end gauge with a GO notch on one end and NO GO notch on the other.

o. GAUGE, ALIGNING, REAR SIGHT B7161446 41-G-13-327 (fig. 13). This gauge is designed to fit over the old "L" type sight. The right rear portion of the gauge, that is parallel to the axis of the bore, is centered through the aperture, and a scribe mark made along this surface is used as an alignment mark when installing the new sight.

p. GAUGE, HEADSPACE 1.295 41-G-199-180 (fig. 16). This gauge is provided for fifth echelon maintenance in addition to the gauges used in third and fourth echelon maintenance.

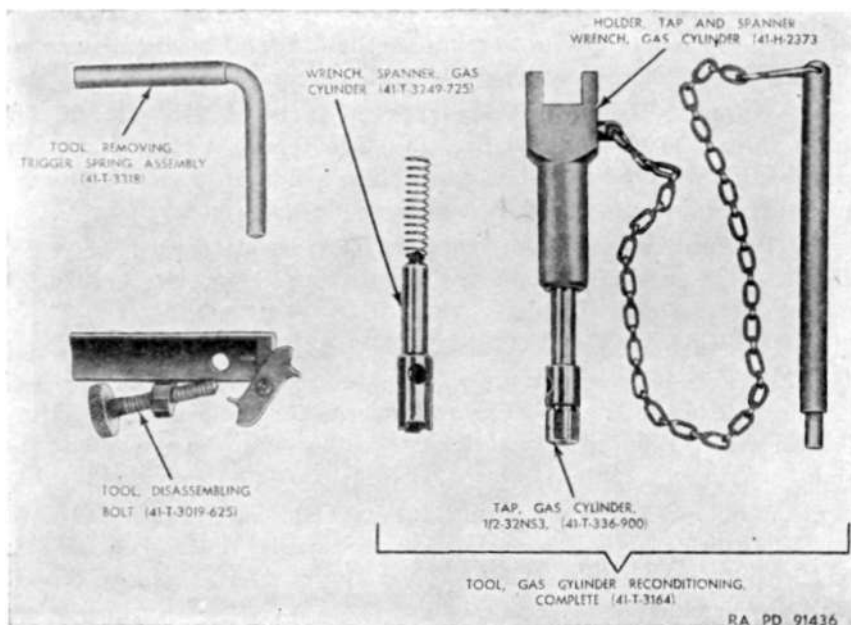

Figure 11. Special tools.

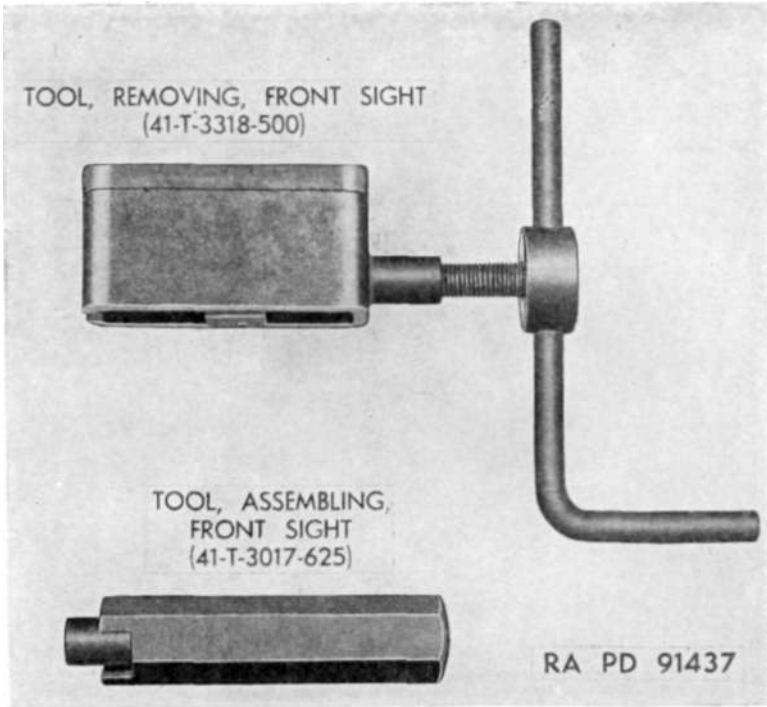

Figure 12. Front sight removing and assembling tools.

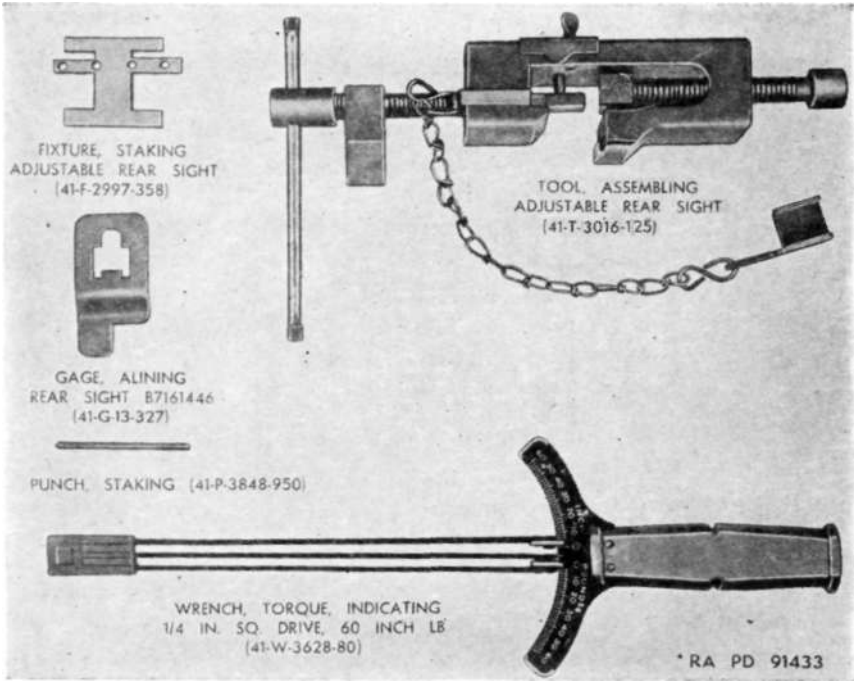

Figure 13. Tools for installing adjustable rear sight.

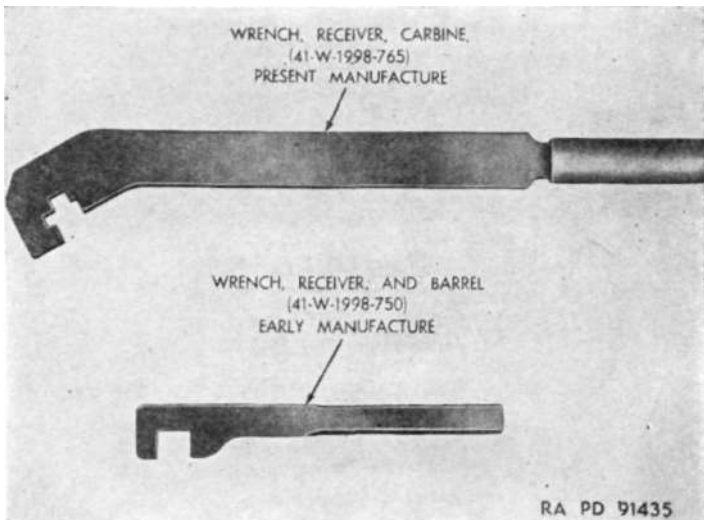

Figure 14. Receiver wrenches — early and present manufacture.

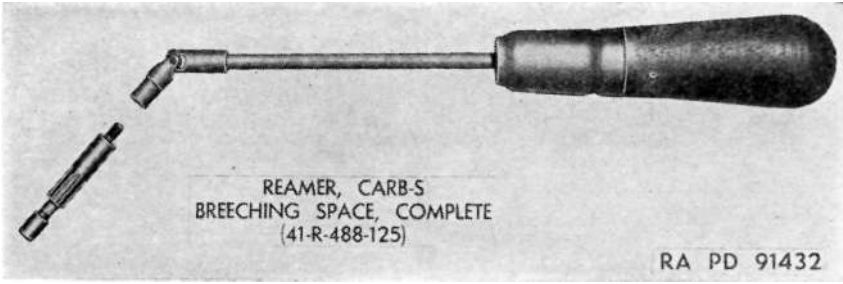

Figure 15. Reamer.

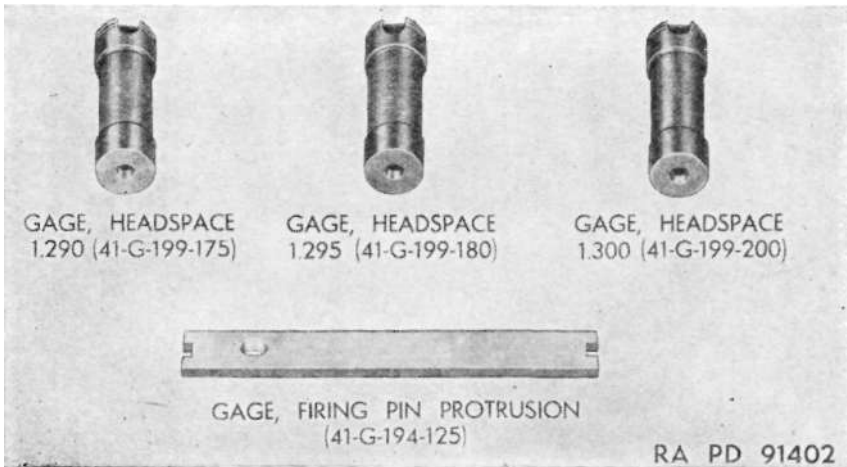

Figure 16. Carbines, cal. .30 M2 and M3 — Gages.

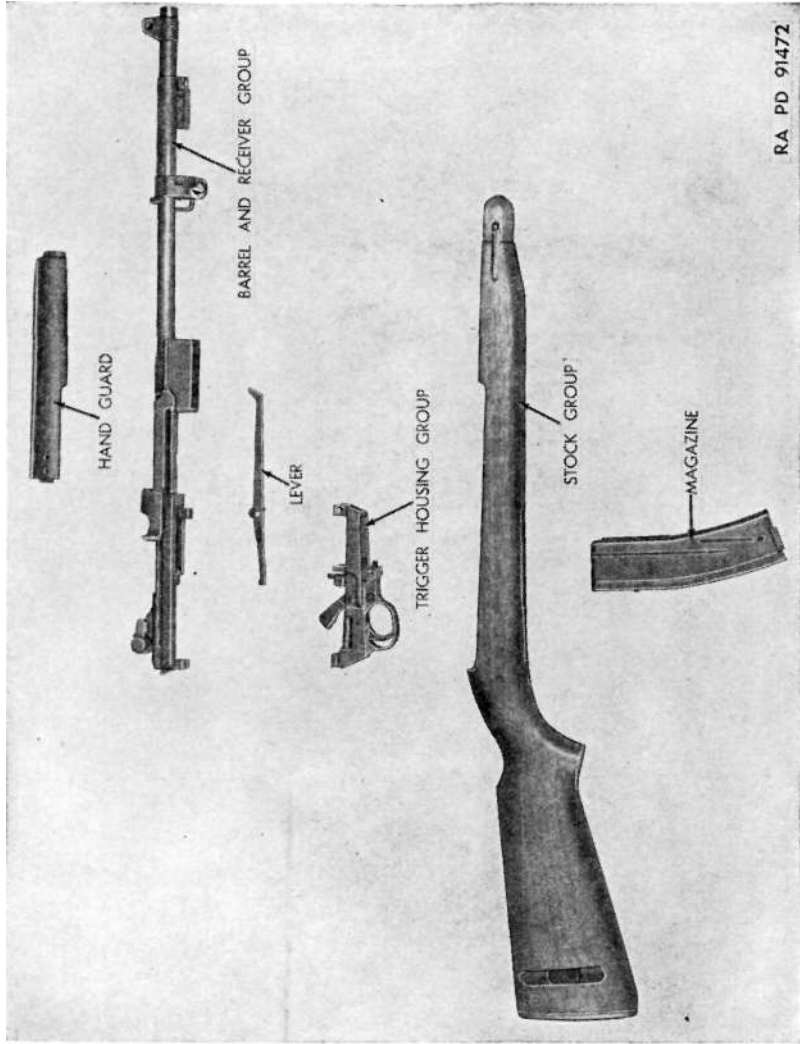

Figure 17. Groups dismantled showing relative positions.

SECTION IV

GENERAL MAINTENANCE

20. Scope

a. Groups are disassembled, inspected, replaced, or repaired, and assembled according to instructions contained in this manual. For information on removal and installation of groups, refer to FM 23-7. A group is a number of parts or assemblies, or both, which either function together in the carbine, or are intimately related to each other and should, therefore, be considered together.

b. For convenience and clarity, the main groups (fig. 17) of the carbine and the accessories, are covered in separate sections of the manual.

c. The overhaul flow chart (fig. 18) represents the various steps necessary in overhaul of the carbines, cal. .30, M1, M1A1, M2, and M3. Fundamentally, there are six stages of overhaul: degreasing, disassembly, refinishing, assembly, final inspection, and packaging.

(1) It is the duty of the disassembly personnel to perform visual inspection on all components as they are removed to insure that un-serviceable components are dropped from the flow of parts as soon as they are removed.

(2) The gauge inspection section should check dimensions with the use of field service gauges and should spot-check components passed or rejected by visual inspection, thereby acting as a control over the previous inspectors.

(3) The section handling wooden components is responsible for inspecting and determining that the components have not been damaged to an extent that will affect the structural strength. This section must also make any minor repairs necessary and refinish and reoil the wooden components when necessary.

(4) It is the responsibility of the parts section to maintain a record of parts on hand and to fill the needs of the assembly personnel by transporting required parts from the bins to the individual assemblers.

(5) Sections have been provided in this flow chart to cover the assembly of certain components ready-to-use for the carbine assemblers. Examples are stock assembly, trigger group, bolt group, etc.

(6) The tools and fixtures required for assembling the carbine are covered in section III of the manual.

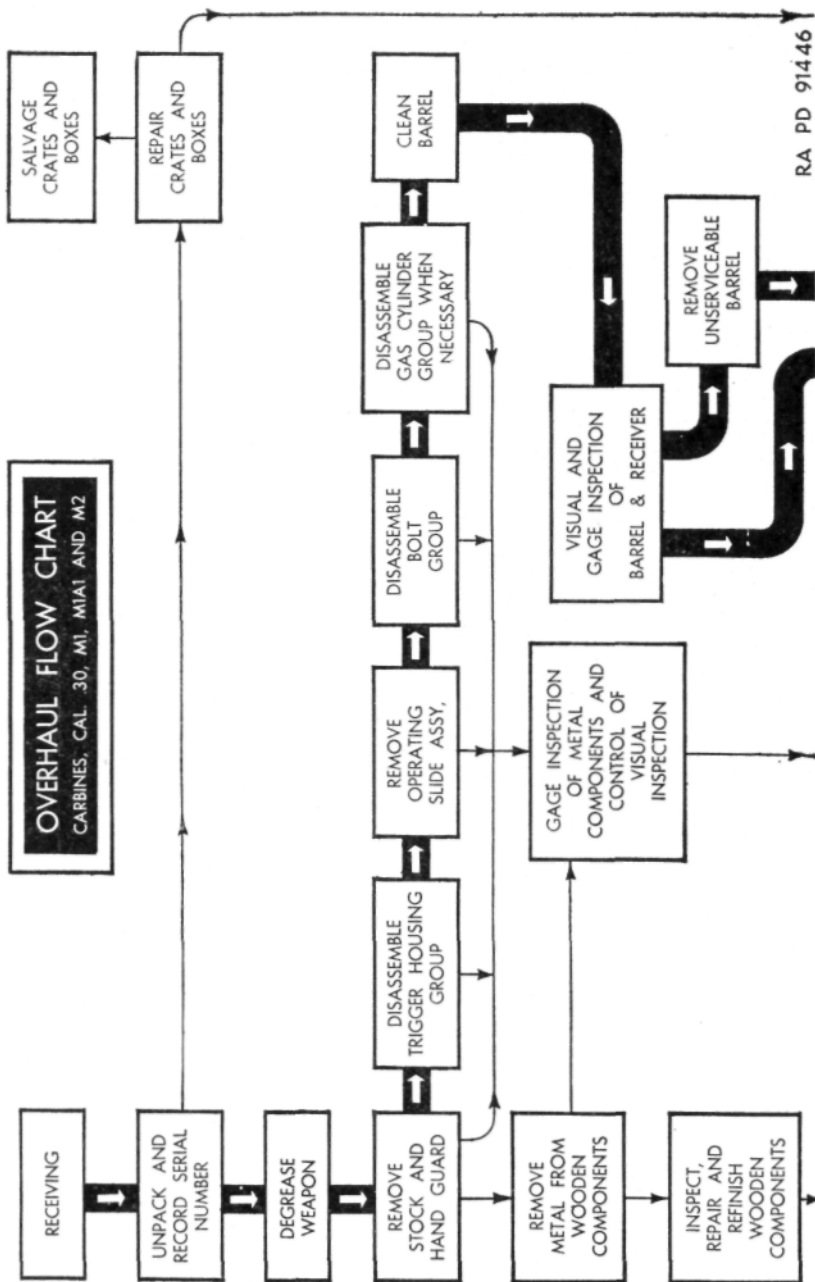

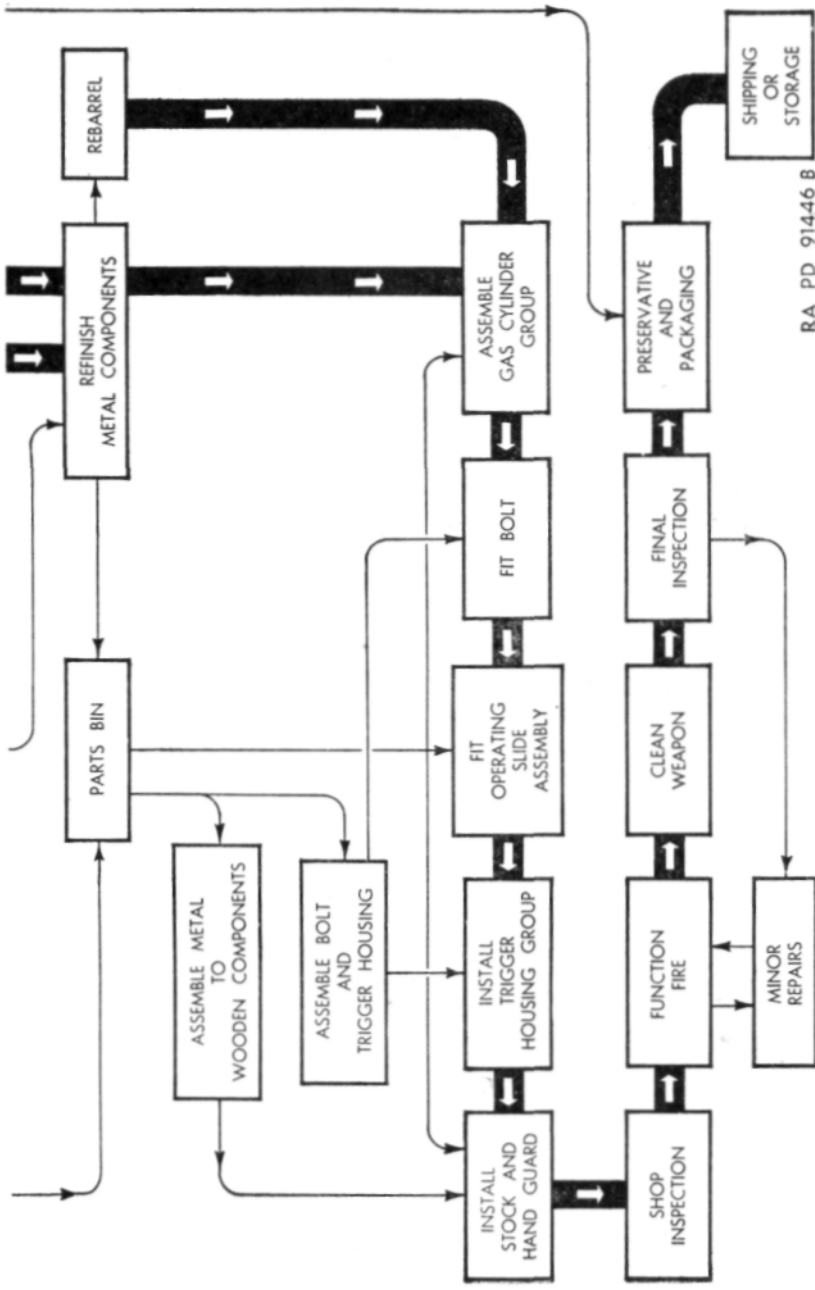

RA PD 91446 B

Figure 18. Overhead flow chart.

Overhaul

ROUTE SHEET

COMPONENT — CARBINES, CAL. .30, M1, M1A1, M2 AND M3.

Operation No.	Operation	Department	Machine	Fixtures	Tools	Gauges
1	Unrate and record serial number.					
2	Check chamber for live round.					
3	Forward chest to box section <i>a.</i> Repair or salvage chests. <i>b.</i> Forward chest to packaging department.					
4	Degrease carbine.			Vapor degreaser.		
5	Remove stock and hand guard <i>a.</i> Remove metal from wooden components (except liner in hand guard). <i>b.</i> Forward metal parts to inspection department. <i>c.</i> Inspect, repair, refinish wooden components.					
6	Disassemble trigger housing group.					
7	Check to see that new type hammer spring, and magazine catch and spring are installed.					

Operation No.	Operation	Department	Machine	Fixtures	Tools	Gauges
8	Remove operating slide assembly.					
9	Disassemble bolt group.				Tool 41-T-3019-625	
10	Disassemble gas cylinder group when necessary.				Tool 41-T-3164	
	Forward parts to inspection.					
	Check parts for wear, breakage, and finish					
11	Forward parts to refinishing department.					
12	Clean barrel.					
13	Visual and gauge inspection of barrel and receiver.					Gauges 41-G-199-175 41-G-199-180 41-G-199-200
16	Remove unserviceable barrel.				Wrench 41-W-1998-750	
17	Refinish receiver and serviceable barrel.					
18	Rebarrel if necessary.				Wrench 41-W-1998-750	

Operation No.	Operation	Department	Machine	Fixtures	Tools	Gauges
19	Check headspace on new barrel.					Gauges 41-G-199-175 41-G-199-200
20	Chamber reamed if necessary and re-check headspace.				Reamer 41-R-488-125	
21	Assemble gas cylinder group.				Tool 41-T-3164	
22	Assemble bolt group.				Tool 41-T-3019-625	
23	Replace bolt group.					
24	Replace operating slide assembly.					
25	Replace trigger housing group.					
26	Assemble metal to wooden components.					
27	Replace stock group and hand guard.					
28	Shop inspection.					
29	Function fire.					
30	Minor repairs.					

Operation No.	Operation	Department	Machine	Fixtures	Tools	Gauges
31	Function fire.					
32	Clean weapon.					
33	Final inspection.					
34	Preserve and package.			Indirectly heated vat for preserving compound.		
35	Shipment or storage.					

(7) After the carbine has been assembled, it is given a brief inspection for proper functioning of the major components. Shop inspectors must locate and report to shop officer any incorrect practice used by shop personnel.

(8) After weapons are assembled function fire and perform any necessary minor repairs.

(9) After function firing, clean weapon for three successive days, using an approved method of cleaning.

(10) Final inspection follows cleaning; this is a detailed inspection to determine positively whether the weapons are up to required standards.

(11) Carbines which meet required standards are packaged in accordance with specified instructions and certified to be serviceable.

21. Allocation of Maintenance Responsibilities

Third and fourth echelon will normally process materiel for use in the hands of troops, and materiel to accompany troops overseas. Third echelon will not normally perform any refinishing. Fifth echelon base shops will process materiel to be placed in storage for reissue. (See fig. 19.)

22. General Methods

Observe carefully the following general procedures during repair and overhaul operations:

a. Assemble groups before replacing them on the weapon. As a part of assembly and replacement of groups, clean, oil for preservation, and lubricate the sliding surfaces, threads, etc.

b. Use only tools that fit snugly on parts. Tools that do not fit will fail or cause damage to those parts.

c. Repair of the carbine normally entails replacement of unserviceable parts or assemblies. Make such repairs as stoning burs, chasing damaged threads, and removing rust and dirt where possible, unless such procedure so alters the part as to fit or function that replacement of the part is advisable. It is the responsibility of the shop foreman to see that such work is being performed competently and correctly. It is the responsibility of individual personnel to see that care is exercised in all maintenance and repair procedures at all times. Parts and assemblies described in the following sections of the manual found by inspection to be worn, damaged, or otherwise unserviceable, are repaired or replaced. Where parts of an assembly are worn or broken, and more time is required to remove the serviceable parts from the assembly than the parts are worth, the assembly should be replaced.

d. Parts requiring replacement due to wear or breakage can be determined only by a complete inspection as generally outlined in section on inspection, and inspection paragraphs pertaining to the

carbine groups, and accessories. Check carefully all springs in the carbine for free length, assembly, and seating. Only special repairs and modifications are covered in the maintenance paragraphs in the following sections.

e. Nomenclature and part numbers appearing on figures in this manual are for identification only. When requisitioning parts and assemblies for replacement purposes, refer to ORD 8 (addendum) of the standard nomenclature lists pertaining to the materiel in question.

23. Removal of Rust

Light rust may generally be removed with a cloth moistened with light oil or rifle bore cleaner. If this does not suffice, use crocus cloth or fine abrasive cloth. Take care not to scratch or alter cleaned surfaces, to remove thoroughly all dirt and abrasive, and to reoil surfaces before assembling the parts.

24. Removal of Burs from Screw Heads and Working Surfaces

During the entire life of the carbine and other materiel, polishing, and stoning are necessary to relieve friction and to remove burs set up by firing and usage. Remove burs on screw heads, threads, and like surfaces with a fine file, or chase out with a die or tap. Remove burs on working surfaces, such as bolt lugs, operating slide grooves, etc., with a fine grain sharpening stone. Smooth rounded contacting surfaces with crocus cloth.

Caution: Take care to stone and file evenly and lightly, and not to remove more metal than is absolutely necessary. Never alter parts or assemblies in any way that will make them noninterchangeable or affect their proper operation or function.

25. Inspection and Replacement of Springs

If weakness of springs pertaining to the guns is suspected, check for set, number of coils, and minimum free length. If springs arc less than minimum free length, replace them. Dimensions of the various springs are given in the inspection paragraph of section pertaining to the group of parts to which the spring pertains. Replace broken, cracked, rusted, or otherwise damaged springs.

26. Testing Carbine After Assembly

a. With chamber empty, test action by retracting the bolt, and releasing. Parts must work freely, and bolt fully close.

b. Feed dummy cartridges loaded into a magazine into the gun, and retract the bolt by hand to determine whether cartridges will feed, extract, and eject properly.

27. Cleaning and Rust Prevention

a. IMPORTANCE OF PREVENTING RUST. Keep materiel in the shop waiting delivery or pick-up clean and oiled to prevent rust at all times. Likewise reoil and lubricate materiel disassembled for cleaning or repair when reassembled. Carefully degrease, reoil and lubricate materiel received from storage when reassembled. It is essential that prescribed cleaning and preservative procedures be followed rigidly. (See TM 9-850.)

b. BORE. It is vital to the accuracy of small-arms materiel to maintain the bore in a rust-free condition. This is accomplished by cleaning thoroughly after firing and by maintaining a preservative coating on the bore surfaces at all other times. Follow the procedures indicated below:

(1) After firing, clean the bore thoroughly with rifle bore cleaner and leave a coating thereon; do not wipe dry. Repeat this procedure on the two following days.

(2) On the third day after firing, clean the bore again with rifle bore cleaner. Do not wipe dry if the weapon is likely to be fired within the next 24 hours. Otherwise, wipe dry and coat with preservative lubricating oil, special.

(3) During prolonged periods when the weapon is not fired, renew the oil film every 7 days, or more frequently if rust appears.

(4) If the weapon is not fired over a long period, remove corrosion or gummy deposits resulting from congealed oil with rifle bore cleaner or dry cleaning solvent, wipe dry, and reoil.

(5) If rifle bore cleaner is not available, the bore may be cleaned with a solution of $\frac{1}{4}$ pound of castile soap or issue soap shaved into 1 gallon of hot water, or a solution of 1 $\frac{1}{2}$ - t a b l e spoonfuls of soda ash to each pint of hot water. Clean the bore with soda ash solution in accordance with detailed procedures in pertinent Field Manual and Technical Manuals. Rinse the bore thoroughly with clear, warm water after cleaning, wipe dry, and oil.

c. MOVING PARTS AND METAL SURFACES. Protect moving parts and surfaces of small arms from rust for short periods by coating with preservative lubricating oil, special. Clean and dry thoroughly before the oil is applied.

d. CLEANING PROCEDURE. Clean by wiping large parts with, and dipping small parts in, rifle bore cleaner or dry cleaning solvent, and then wipe dry. In humid atmosphere, be sure to use moisture-free patches for wiping. Wipe a light film of preservative lubricating oil (special) over all parts. Inspect daily to detect development of rust, and renew the oil film as frequently as necessary to provide adequate protection. Refer to TM 9-850 for detailed instructions on the use of cleaning and lubricating materials.

28. Rust Preventives and Cleaning Materials

a. PRESERVATIVE LUBRICATING OIL (SPECIAL). Use lubricating oil (special) for lubrication of all moving parts and for protection against rust of metal parts of small arms, except when exposed to high humidity, moisture, or salt air at temperatures above 32° F. It replaces preservative lubricating oil (light). Either of the oils may be used at temperatures above 0° F. for weapons fired on the ground, until stocks of preservative lubricating oil (light) are depleted. Use only preservative lubricating oil (special) for ground weapons at temperatures below 0° F. and for lubrication of the moving parts of aircraft small arms at all temperatures. These oils have rust-preventive as well as lubricating properties, but should be depended upon to provide only day-to-day protection from rust. Make frequent inspections to insure maintenance of an adequate oil film. In an emergency, use lubricating oil (light) but do not depend upon it for protection from rust. When it is used, inspect materiel daily for rust, clean if necessary, and coat lightly with oil.

b. PRESERVATIVE LUBRICATING OIL (MEDIUM). (1) Lubricating oil (medium) is comparable in weight (viscosity) to engine oil (SAE 30). It contains rust inhibitors which provide preservative characteristics superior to those of engine oil and the lighter preservative lubricating oils, especially under excessive moisture and humid conditions, and for short-term storage.

(2) Use this oil to lubricate small arms and machine gun mounts under the following conditions:

(*a*) Landing operations, especially when the weapons may be submerged in water or exposed to spray.

(*b*) Above 32° F. in humid and salt areas.

(*c*) Above 32° F. under excessive moisture conditions.

(*d*) To coat exposed, nonworking surfaces of aircraft weapons which are subject to rusting. Use preservative lubricating oil (special) on moving parts and in bores in all temperatures.

(3) When preservative lubricating oil (medium) is used for temporary storage, make frequent inspections to determine that the oil film is adequate to prevent rusting.

c. RIFLE BORE CLEANER. (1) This cleaner is prescribed for cleaning bores after firing and during periods of inactive service. It is applied by means of patches saturated with the cleaner, and provides faster and more complete cleaning than other materials such as soda ash, soap solutions, or hot water. Rifle bore cleaner has the additional advantage of containing rust-preventive properties which will provide adequate protection against rust for a period of 24 to 48 hours during which the bore is not oiled. This is especially desirable in combat areas where weapons must always be ready for immediate firing.

(2) After prolonged firing, the most efficient cleaning action is ob-

tained when the tube is cool enough to touch with the hand. Temperatures above 150° F. will evaporate some of the solvents in the rifle bore cleaner, thereby reducing its cleaning efficiency.

(3) When the supply of rifle bore cleaner is limited, it may be diluted with 50 percent water in temperatures above 32° F. without reducing the cleaning efficiency materially. However, this will reduce the rust-preventive qualities; therefore bores cleaned in this manner must be dried and coated with oil immediately.

(4) Rifle bore cleaner will also be used in lieu of dry cleaning solvent to clean other small-arms parts. The parts are wiped dry after cleaning and the prescribed oil applied.

d. RIFLE GREASE. This grease is a lubricant and preservative for use on certain areas of the carbines, cal. .30, M1, M1A1, M2, and M3, when exposed to rain or sea water spray. When exposure to rain or sea water spray is anticipated, the following surfaces and areas will be wiped dry with a clean, dry cloth and then lightly coated with rifle grease by rubbing it on with the finger tip:

- (1) Surface of the bolt actuating cam on the operating rod.
- (2) Locking recesses in the receiver.
- (3) The hammer actuating cam on the rear of the bolt.
- (4) Upper and lower circular surfaces forming the receiver bridge, at rear end of bolt.

e. DRY CLEANING SOLVENT. This is a petroleum solvent used for degreasing materiel, and also to clean small arms when rifle bore cleaner is not available. Dry cleaning solvent removes all oily films from metal parts and its use is therefore always followed by application of a lubricating or preservative film. Take particular care after cleaning to wipe all surfaces completely dry of solvent, and then to apply a thin film of oil immediately.

f. RUST-PREVENTIVE COMPOUND (LIGHT). This compound is designed especially to provide protection of metal parts against rusting for long periods while small arms are boxed and in storage. It is a gelatinous semisolid and is warmed before application. (See TM 9-850 for instructions covering its application.) Remove rust-preventive compound (light) completely from all parts of small arms before firing, particularly in cold climates, because it will harden at low temperatures and cause serious malfunctioning.

g. RUST-PREVENTIVE COMPOUND (HEAVY). This is a heavy, grease-like, nondrying, petrolatum type compound. Heating and application instructions are the same as those prescribed for rust-preventive compound (light). (See TM 9-850 for detailed procedures.) This compound is prescribed only for the exteriors of bearings and joints of machine gun mounts being prepared for shipment or long-term storage, and is not used on weapons.

29. Storage and Shipping

a. Preservative lubricating oil (medium) is intended for preservation of small arms in temporary storage not exceeding 30 days. For shipping or long-term storage, use rust-preventive compound (light).

b. Before applying rust-preventive compound (light), clean all parts thoroughly with dry cleaning solvent and dry. Do not touch the parts with bare hands as perspiration accelerates rusting. The preferred method of applying rust-preventive is by dipping the parts in the compound heated to about 180° F., but not over 200° F. Do not heat the compound over a flame as there is danger of it catching fire. Direct heat destroys rust-preventive qualities; therefore use an indirect method, such as steam or hot water, for heating. If heating facilities are not available, brush on rust-preventive compound (light) at temperatures as low as 60° F. One way to apply indicated rust-preventive to the bore is to dip a cleaning brush in rust-preventive compound and pass it through the bore several times. The brush should be clean. Do not wrap small arms coated with rust-preventive compound in cloth of any kind before placing in boxes for storage or shipment; cloth absorbs atmospheric moisture and causes rusting. Coat the support cleats and supporting straps in boxes with rust-preventive compound before the materiel is put into the box. When placing prepared materiel in boxes, handle pieces without placing fingers on metal surfaces.

c. Small arms removed from storage and put into service must have all traces of rust-preventive compound removed from the parts by cleaning or washing in dry cleaning solvent or Diesel fuel oil or placing in a vapor degreaser. Do not use strong alkaline solutions. Take special care to clean thoroughly all recesses in which springs or plungers operate. Failure to do this may cause malfunctioning at normal temperatures, and will certainly do so when rust-preventive compound congeals solidly at low temperatures.

SERVICEABILITY CHART - CARBINE, CAL. 30. M1, M1A1, & M2			
ITEM	IN THE HANDS OF TROOPS	TO ACCOMPANY TROOPS OVERSEAS (SB 9-2)	TO BE PLACED IN STORAGE FOR REISSUE
FINISH	Exposed surfaces must be dull enough to prevent glare.	Intact enough to prevent glare.	Approximate new
STOCK	Not damaged to extent that it will affect strength.	Seasoned checks, small dents, and insignificant cracks are acceptable.	Approximate appearance of new stock. Must be sanded and refinished if necessary. Patch work and reinforcing that does not affect strength is acceptable.
HAND GUARDS	Not damaged so as to affect strength. Some looseness when assembled is acceptable. Liner must be tight.	Seasoned checks and cracks not at critical points are acceptable. Liner must be tight.	Seasoned checks and cracks which have been reinforced by pins are acceptable. Some looseness when assembled is acceptable. Liner must be tight.

RA PD 91422

BORE	Pitting less than width of land or groove and less than 3/8" long is acceptable.	Fine uniform pitting, but with sharp lands is acceptable.	A few fine pits, but with sharp lands is acceptable.
HEADSPACE	Max. 1.300 Use gage 41-G-199-200	Max. 1.300 Use gage 41-G-199-200	Rebarreled Min. 1.290 Max. 1.295 Use Gages 41-G-199-175, 41-G-199-180 Not Rebarreled Min. 1.290 Max. 1.300 Use Gages 41-G-199-175, 41-G-199-200
TRIGGER PULL	Min. 5 lb Max. 7 lb	Min. 5 lb Max. 7 lb	Min. 5 lb Max. 7 lb
FIRING PIN PROTRUSION	No Check	No Check	Min. .048 Max. .065 Use gage 41-G-194-125

RA PD 91422B

Figure 19. Serviceability chart.

SECTION V

TRIGGER HOUSING GROUP

30. Disassembly

a. REMOVING TRIGGER SPRING (fig. 20). (1) Insert the tube portion of the trigger spring removing tool (fig. 21) in the recess in the rear of the trigger housing containing the trigger spring, compress, and retain the trigger spring within the tube of the tool.

(2) Turn the handle of the tool one-quarter turn counterclockwise.

(3) Withdraw the tool and spring while pushing the handle of the tool slightly to the right.

b. REPLACING TRIGGER SPRING. Replace the spring by reversing the procedure of removal. When the spring is in position in the retaining groove of the trigger, depress the trigger and withdraw the tool from the housing.

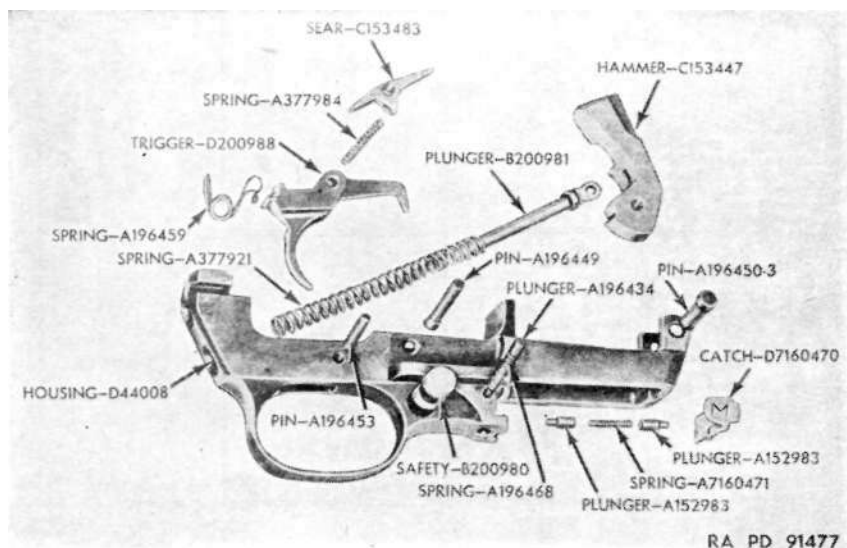

Figure 20. Trigger housing group — disassembled.

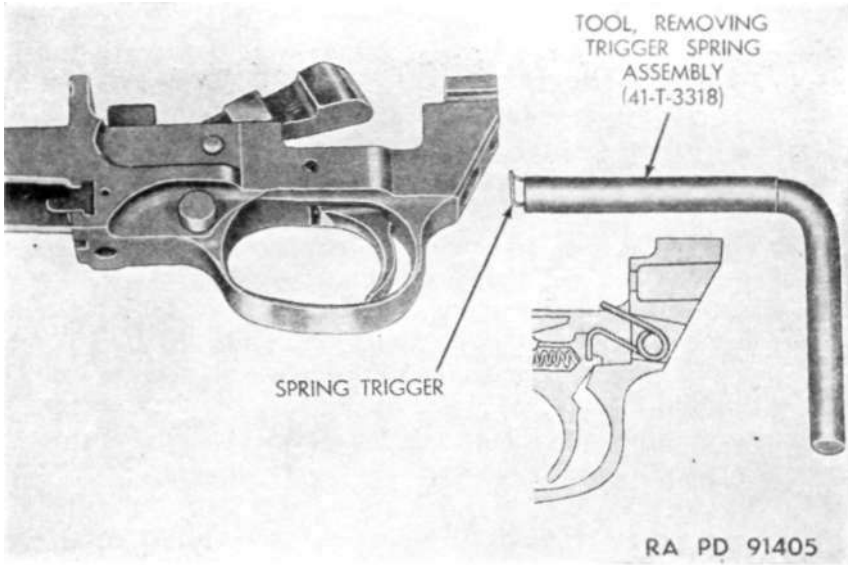

Figure 21. Installing trigger spring.

31. Inspection

a. TRIGGER HOUSING. Inspect housing for deformation, worn or burred pinholes, worn or burred retaining lugs, bent trigger guard bow, foreign matter in recesses, burred magazine catch guideway, and

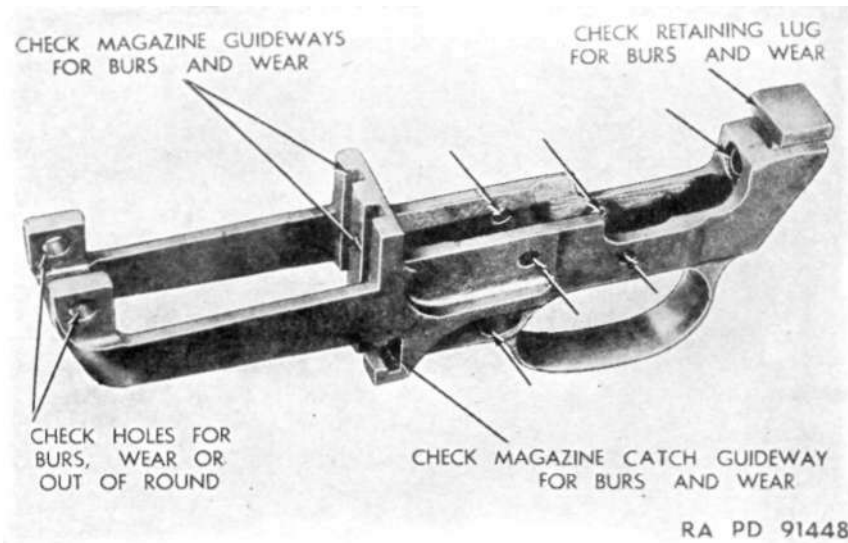

Figure 22. Trigger housing, carbines, cal. .30, M1 and M1 A1 — points of inspection.

rust. Inspect housing for looseness of retention with receiver; there should be no excess shake. Check counterbore in hammer spring plunger aperture for burrs.

b. TRIGGER HOUSING RETAINING PIN. Inspect retaining pin for wear, burrs, rust, and cracks at point where retaining spring seats in pin (early design). Inspect spring in pin (early design) (fig. 23) for positioning and looseness. Head of pin should seat flush with face of housing when in position, and end of pin retaining spring should grip lip of pinhole for retention. (Head of early design pin is seated in counterbore, and end of spring is in bevel of lip of pinhole. Pins of recent design have no spring.)

c. HAMMER. Check hammer for worn pinhole, burred or dented face or bolt cam, worn or burred plunger retaining slot, burrs, and rust. Check sear notch for wear, burrs, and foreign matter. Bearing face of sear notch should be level and angle between faces 115° with tolerance

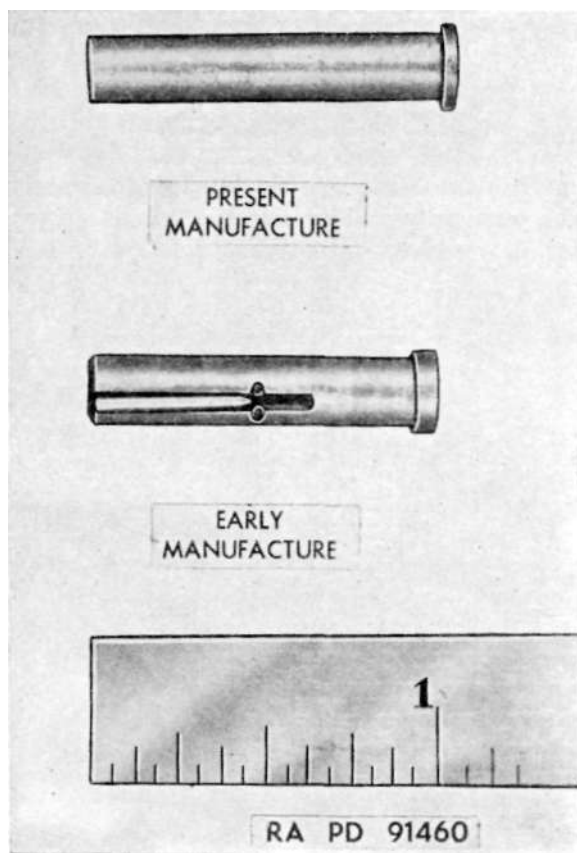

Figure 23. Trigger pins carbines, cal. .30, M1 and M1A1 — early and present manufacture.

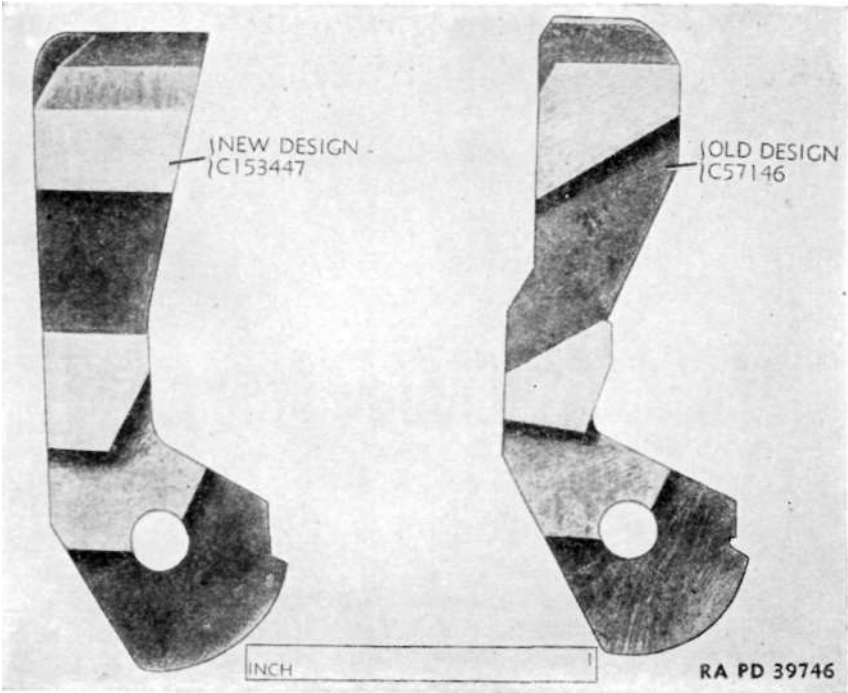

Figure 24. Difference in contour between the new and old design hammers for carbine cal. .30.

of 1 degree. In hammers of recent design this angle is 118° with a tolerance of 30 minutes. Inspect hammer pin for wear and burrs, hammer for looseness on pin, and pin for looseness in trigger housing. Movement of hammer on pin should be free, but without shake. Inspect hammer stop lug on left face of hammer for wear and burrs.

Note. Replace early design hammer (C57146) with hammer (C153447) of recent design (fig. 24).

d. HAMMER SPRING AND PLUNGER. Inspect hammer spring plunger for deformation, wear, burrs, and rust. Inspect fit of head of plunger in slot in rear face of hammer. Head should seat evenly and positively in slot. Inspect hammer spring for functioning, deformation, and set. Free length of spring is 2.616 inches.

Note. Replace early design hammer springs that had a free length of 2.125 inches, 22 coils, and wire diameter of 0.046 inch with hammer spring (A377921) of recent design that has a free length of 2.616 inches, 26.5 coils, and wire diameter of 0.042 inch, (fig. 25).

Hammer Spring (Present Manufacture), A377821

Number coils	26.5
Mean assembled height	1.431 in.
Load at mean assembled height16 ± 1 lb
Operating height	1.171 in.
Load at operating height19 ± 1 lb

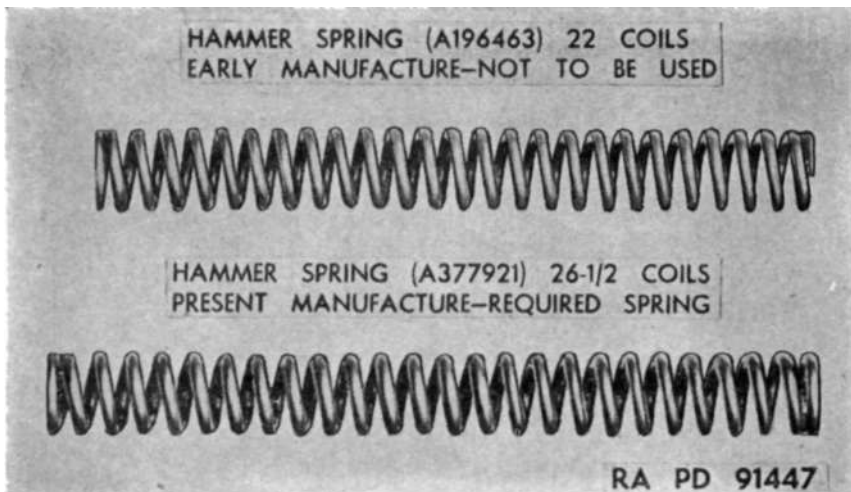

Figure 25. Hammer spring — early and present manufacture.

e. TRIGGER. (1) Inspect trigger for movement on trigger pin and pin for seating in trigger housing. Trigger should rotate freely on pin but have no shake. Pin should fit snugly with a push fit, in housing. Inspect clearance of trigger tip with bow, and rear of trigger with housing when fully retracted.

(2) Check top of pedestal where sear seats when hammer is cocked, for levelness, wear, and burrs. Check trigger spring notch for burrs and foreign matter. Check forward end of trigger which engages with safety, for deformation and burrs. Check sear spring seating recess for foreign matter.

(3) Triggers of early manufacture had a 4° or 8° angle on the forward face of the pedestal which was conducive to trigger hang. When trigger hand exists it can be eliminated by replacing the trigger with one of recent manufacture having a 20° angle on forward face of pedestal.

f. TRIGGER SPRING. Check trigger spring for deformation and rust. Check seating of spring in seating notch in trigger, and positive retention of spring in housing aperture. Bow end of spring should seat level in bottom of seating notch in trigger and rear coiled section should be held firmly in housing aperture by the force of spring tension. Tips of spring should be slightly spread.

g. SEAR. Check sear for movement on trigger pin. Sear should rotate freely about pin and have backward and forward movement due to elongated pinhole but should have no vertical play. Check pinhole for excessive wear. Check bearing surface on lower side of rear end of sear nose for wear and burrs. Bearing face of sear nose should be level. Check sear spring seating recess in sear for foreign matter. Hammer nose of sear is slightly rounded and chamfered on lower edge. Sear

of current manufacture are identified by a hole drilled to the rear of the sear pinhole. Sear that have been gauged to specified dimensions are identified by a grinding tool mark. (See fig. 26.) When excessive trigger pull exists it may be caused by the use of an old type sear. Replace old sear with one of current manufacture.

h. SEAR SPRING. Check sear spring for positive seating in trigger and sear, and for functioning, rust, and set. Free length of spring is 0.60 (approximately $\frac{5}{8}$) inch.

Sear Spring (Present Manufacture), A377984

Number coils.....	15
Mean assembled height.....	.478 in.
Load at mean assembled height.....	3.2+0.3 lb
Operating height.....	.422 in.
Load at operating height.....	4.1±0.4 lb

i. SAFETY. Test safety for positive positioning, left and right. Check body for burrs and rust, and check spring plunger recess and trigger slot for burrs and foreign matter. Check safety spring plunger for wear and check plunger spring for functioning, deformation, and set. Free length of spring is 0.625 inch. Check magazine catch retainer plunger for wear and burrs. Safety and magazine catch are both retained in the trigger housing by the safety spring; the safety plunger

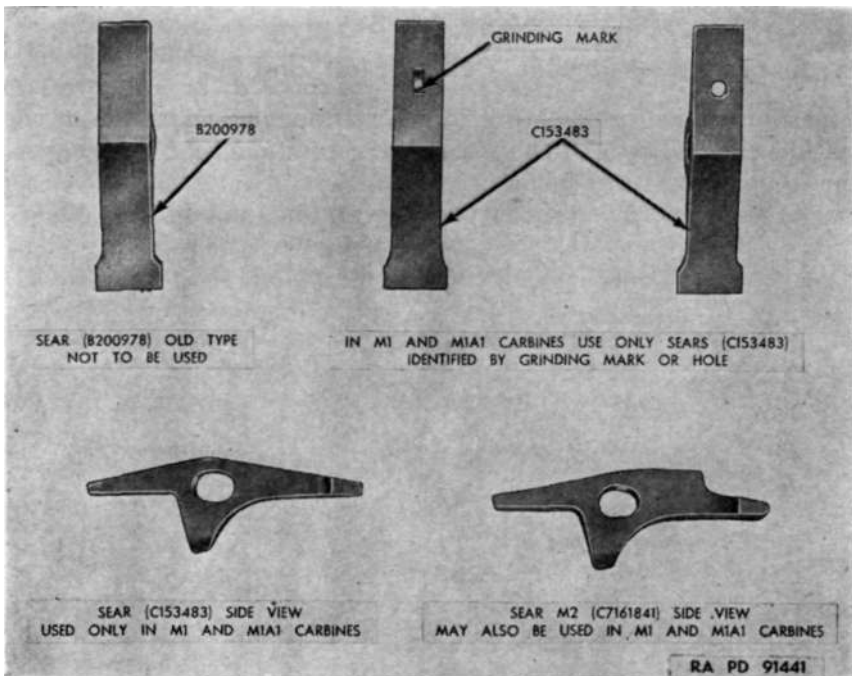

Figure 26. Sears — serviceable and unserviceable.

is assembled to one end of the spring and the magazine catch retainer plunger to the other end. Last coil on both ends of spring is spread slightly to retain spring in plungers when assembled.

j. **MAGAZINE CATCH.** Test function of magazine catch. It should return to position when pressed and released. Check catch for free movement in guidway, deformation, worn or burred retainer plunger recess, and worn or burred magazine retention lugs. (See fig. 27.) Check magazine catch spring plunger for retention on spring, wear, and burs, and check spring for functioning, deformation, and set. Free length of spring is 0.813 (approximately $\frac{7}{8}$) inch. When assembled, last coil of spring is contracted slightly and fits into groove in shank of plunger for retention. Magazine catch (B7160470), and magazine catch retainer plunger with safety plunger, assemblies (B7160472) should be used. This is the catch that protrudes outward farther than the old design, thereby providing greater engagement between the catch and the nibs on the back of the magazine. It can be readily identified by the letter "M" on the right-hand side. Illustrated in figure 27 are: old type magazine catch B200975, which is to be discarded; new type magazine catch 7160470, which has a letter "M" stamped on the thumb piece as an identifying feature; and new type magazine catch 7161842, which is currently supplied with the carbine M2. This can also be used on the carbines M1, M1A1, and M1A3. Its identifying features are an underlined "M" stamped on the thumb piece and a supporting tang.

32. Inspection — Carbine, Cal. .30, M2, and M3

Inspection of the carbine M2 is in general the same as for the standard M1 carbine. Special points to observe pertaining to the conversion components are as follows:

a. **DISCONNECTOR.** See that bearing slot in front end of discon-

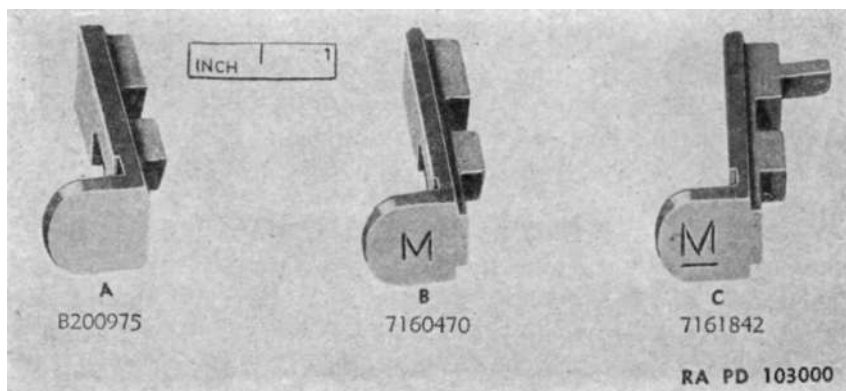

Figure 27. Old and new type of magazine catch — carbines, cal. .30, M1, M1A1, M2, and M3.

necter is free from foreign matter and burs, and is lightly lubricated. See that disconnecter spring is not weak, rusted, or broken, that spring well is free of foreign matter, and that plunger is free of burs. Lubricate plunger occasionally. Expanded end of coil of spring should seat in plunger for retention. Check rear end of disconnecter for burs and wear.

b. DISCONNECTOR LEVER ASSEMBLY. See that lever is straight, not twisted or loose on pivot and that ends are free from burs and wear. Offset in rear section is for alignment with disconnecter and should not be straightened. Be sure toe (front end) of lever bears squarely on cam on operating slide and is (slide retracted) under raised boss when lever is fully seated in the housing. See that pivot hole is not enlarged. Rear end should not bind in cam of disconnecter when assembled. Examine trigger housing and selector pin to see that pivot on crank end is free from burs and not worn. Keep pivots lightly lubricated. If the pin is rotated by the selector permitting inadequate positioning of lever in full automatic fire, check to see that straddle cuts in straight end of pin are free from burs, retain selector firmly, and are not worn so it will cause lost motion.

c. SELECTOR GROUP. See that crank pin slot is not worn so it will cause lost motion or impair security. See that spring recess in rear end is free from foreign matter and will retain spring securely. See that selector spring is bent in only one plane (not twisted), and both ends seat securely in their retention recesses. If spring is loose when assembled, straighten slightly.

d. TRIGGER HOUSING. See that selector spring retention slot in left side of magazine post is free from foreign matter and seats spring securely, so it will not turn when assembled.

e. MAGAZINE CATCH. See that projection on left end of catch is neither bent nor burred. Magazine catch must have this identification mark "M". (See fig. 27.)

f. HAMMER. Inspect milled cut on lower right side of hammer, which allows clearance for disconnecter, for burs and wear.

g. SEAR. Inspect top front portion (camming surface for disconnecter) for burs and wear.

33. Maintenance and Repair

a. GENERAL. Replace all broken, worn, or otherwise unserviceable parts. Remove burs and rust as explained in paragraphs 23 and 24. Weapons must have the current applicable modifications, and instructions contained in future Technical Bulletins must be followed. Note that M2 components (fig. 5) are not interchangeable with those of the M1 and M1A1.

b. HAMMER FAILS TO COCK. This condition may be due to damaged sear, broken sear spring, burs or foreign matter in sear notch in hammer, or failure of bolt to move far enough to the rear on recoil movement to cock hammer. Examine parts; clean and replace if necessary.

c. STONING NOSE OF SEAR. If sear nose or hammer notch becomes burred or unevenly worn, preventing proper seating of nose of sear in notch, the burs may be removed in an emergency, and uneven surface leveled with a fine grained sharpening stone. Stone surface to a polish only, being careful to maintain angle of face. Stoning should be done only by trained ordnance personnel. If possible, parts should be replaced by selective assembly.

d. CORRECTING TRIGGER PULL. (1) A light or heavy trigger pull may be caused by foreign matter or burs in the sear notch in the hammer, on the nose of the sear, on the top of rear end lip of trigger where the rear end of sear rests, or in the elongated pivot hole in the sear. Such burs or foreign matter will prevent nose of the sear from seating fully in hammer notch. To correct, remove foreign matter or stone burred surfaces to a polish, using a fine grained sharpening stone, taking care to maintain surfaces, angle, and sharp edges. Replace badly burred or damaged parts. Stoning should be done only by trained ordnance personnel.

(2) A light pull may also be due to a weak or broken sear spring which will not seat the sear fully in the hammer notch before the pressure from hammer spring is applied to the nose of sear through the hammer. Correct by removing foreign matter or replace sear spring.

(3) Uneven surface of hammer notch or worn nose of sear may also cause a light pull. Correct by stoning surfaces evenly, being careful to maintain angles and sharp corners of faces stoned.

e. TRIGGER HOUSING LOOSE ON RECEIVER. (1) If T-shaped lug on rear end of trigger housing becomes worn so it becomes a loose fit in retaining L-shaped lugs on rear end of receiver, peen lightly to spread lug, then file to fit.

(2) The forward lugs of trigger housing may be similarly treated to attain close fit.

Caution: Do not peen or squeeze in the lugs on the receiver as they are hardened. Any attempt at tightening should be done by peening of trigger housing lugs when necessary.

f. SAFETY STICKS. If the safety sticks when pushed to right or left, the safety spring plunger is burred or missing or the plunger seats in the safety are burred or too deep. In safeties of early design there are two seating recesses separated by a ridge of metal. If edges of this ridge are too sharp or steep the plunger will not cam over it when the safety is shifted. In safeties of recent design this ridge is sloped and cut straight through. If such a safety is not procurable, the edges of the ridge may be stoned down sufficiently to allow the plunger to cam over, but sufficient retention should remain to hold the safety positively in either the SAFE or FIRE position.

34. Functional Check

a. Cock hammer and check seating and positive retention to limit

of sear nose in hammer notch. Continue to retract hammer of rearward movement and observe forward movement of sear to maintain retention. Sear should continue to contact hammer throughout movement. Pull trigger; sear should release hammer crisply. Trigger pull should be from 5 to 7 pounds. Release trigger. It should move positively to forward position under force of trigger spring and be held there firmly and without shake even when sear is not assembled. When trigger is in forward position and hammer cocked, the sear should rest upon or above top of rear pedestal of trigger.

b. Push safety all the way to right and attempt to pull trigger. In this position trigger should be blocked and retraction impossible. Push safety all the way to left and pull trigger. Trigger should be free and full retraction possible to release the hammer. When safety is positioned to right, the left face of the safety should be flush with trigger housing, and when pushed to left, the right face should be flush. If this is not the case, or safety sticks, the safety plunger or plunger spring may be damaged, plunger missing, or plunger seat burred.

c. Push magazine catch to left and release. Catch should return positively and smoothly to its original position. Magazine catch must be of the latest design (See fig. 27.)

SECTION VI

OPERATING SLIDE ASSEMBLY

35. Inspection

a. OPERATING SLIDE (fig. 29) for bent or cracked rear bar, deformation, excessively worn guide lugs, burs, and corrosion. Inspect bolt camming lug recess for wear and burs. Inspect spring guide seating recess in rear face for wear, burs, and foreign matter. Inspect front face of slide where it contacts piston, for levelness. Unevenness at this point may cause malfunction. Check camming surface on M2 and M3 carbines for burs and wear (fig. 29) on right-hand side of slide, where shank of handle joins slide.

b. OPERATING SLIDE STOP. Inspect stop (fig. 28) for wear and burs, looseness in operating slide, and rust. Inspect stop spring for functioning, lack of friction with stop, and for set. Free length of spring (A7312453) is 0.270 (approximately $\frac{1}{4}$ inch). Inspect spring for foreign matter. Replace all slide stops, springs, and retaining pins with slide stops and springs of late manufacture. (See fig. 29.)

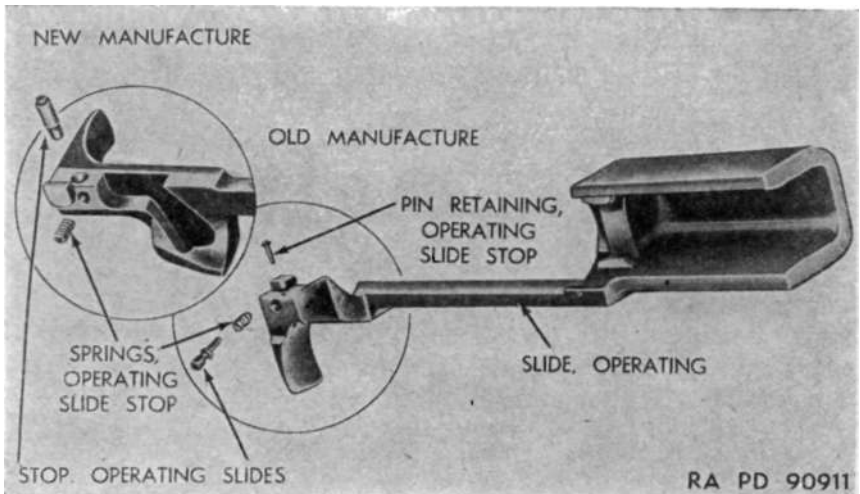

Figure 28. Operating slide group carbines, cal. .30, M1 and M1A1.

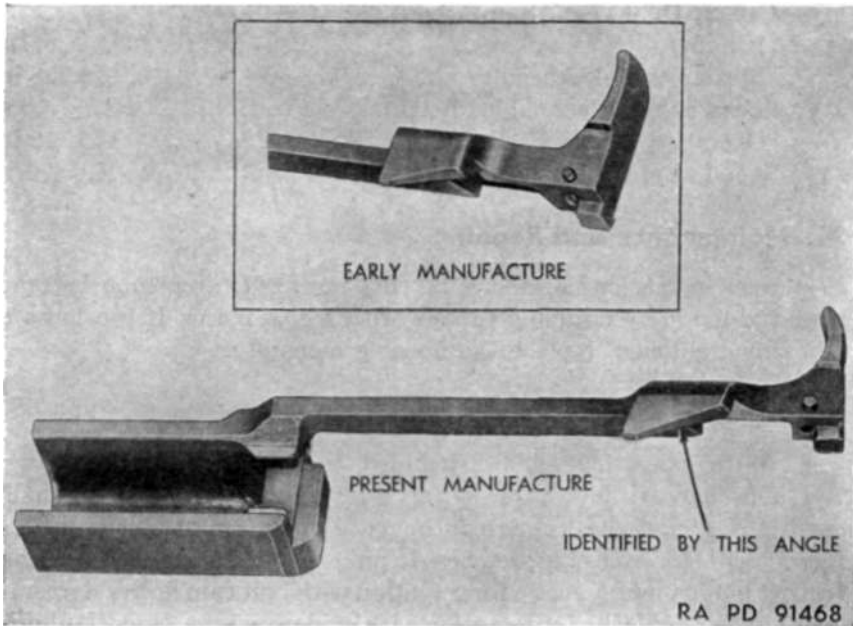

Figure 29. Operating slide assembly — early and present manufacture.

c. OPERATING SLIDE SPRING. Inspect operating slide spring for kinks, rust, and set. Free length of spring is 10.28 (approximately $10\frac{1}{4}$) inches. First coil of rear end of spring (early design) is spread slightly to retain spring in well or housing tube of receiver. (See *d* below.)

d. OPERATING SLIDE SPRING GUIDE. Inspect operating slide spring guide for deformation, burs, worn or burred nose, and rust. Shank of guide should be straight. Nose of guide should be free from burs to insure positive seating in its recess in rear face of operating slide. With spring assembled to guide, insert in housing, and hand operate to test freedom of movement in housing tube, or in well in receiver ("alternate" design receiver).

e. SLIDE SPRING HOUSING. Inspect inside and outside of operating slide spring housing for dents, splits, rust, and foreign matter. Inspect spring retainer for looseness in tube and positioning lug on retainer for burs and wear. Some tubes have a pressed out lug on the side and a slot in the rear. This lug seats in the operating slide dismounting slot in the receiver (limited design), and the rear slot mates with a small projecting lug in the rear end of the housing tube bed groove in the receiver. The lug should not be bent or burred, and the edges of slot should be clean. If lug is damaged or missing, replace the tube with a new one.

f. CHECK OPERATING SLIDE SPRING.

Number of coils.....	121
Mean assembled height.....	8.758 in.
Load at mean assembled height.....	2.8 ± .25 lb
Operating height.....	5.715 in.
Load at operating height.....	8.6 ± 1 lb

36. Maintenance and Repair

If retainer in rear end of operating slide spring housing tube becomes loose tighten it by crimping tube in with a cold chisel. If too loose to be easily tightened, replace the housing assembly.

37. Functional Check

a. With operating slide assembled to carbine barrel, receiver, and bolt, and without slide spring and guide assembled, manually operate slide and check for smoothness of operation of bolt and slide. Inspect slide for excessive looseness in guideways of barrel and receiver. Inspect bolt camming recess for retention with bolt cam lug, and operating slide rear guide lug for retention with guideway in receiver. It should not be possible to disengage slide from guideway except when rear guide lug is aligned with relief cut in guideway in receiver. At this point, a slight pull out and up should disengage slide from receiver, but not from bolt cam lug. This should not be possible, without undue force, until barrel guide lugs on slide are aligned with relief cuts in barrel guideways and slide is rotated. If slide can be disengaged otherwise, rear bar is bent or guide lugs are excessively worn.

b. Test function of operating slide stop. When bolt is fully retracted and stop pressed into its retaining groove, it should positively "hang" slide and bolt in that position. If bolt closes when receiver is jarred, the stop and/or retaining groove are worn or stop friction spring is missing, broken, or set. Stop should be cammed out of groove and lie flush with bottom surface of slide when bolt is retracted. Friction pressure of stop spring should be sufficient to hold stop positively in retracted position notwithstanding jar of bolt at end of rearward movement. (Stops of early design were spring retracted when slide was moved slightly to rear to relieve friction between stop and face of notch in receiver.)

SECTION VII

BOLT GROUP

38. Disassembly (fig. 30).

Assemble bolt disassembling tool (41-T-3019-625) to bolt. (See fig. 31.) Turn thumbscrew until extractor plunger is depressed, making it possible to remove the extractor. Remove tool and disassemble bolt.

Note. Any effort to "punch out" the extractor will shear off the extractor plunger, or the extractor retaining lip; depress the plunger with a suitable instrument before removing the extractor.

39. Inspection

Inspect locking lugs of bolt for cracks, excessive wear, and burrs. Inspect rear (hammer) camming surface and firing pin tang slot for wear and burrs. Check face of bolt for excessive wear and enlarged firing pin-

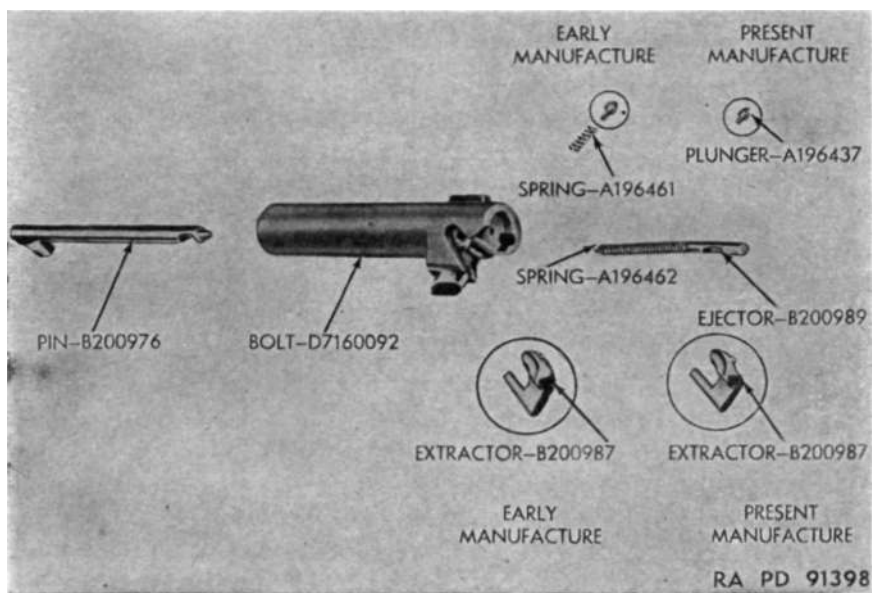

Figure 30. Bolt — disassembled.

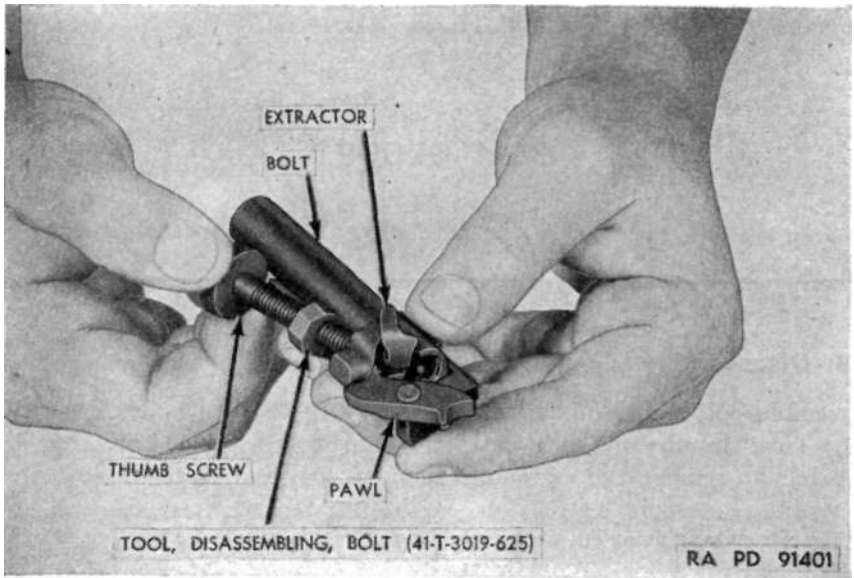

Figure 31. Disassembling bolt — carbines, cal. .30, M2 and M3.

hole. Check pinhole and pin housing tunnel for foreign matter and corrosion. Check forward lower (feeding) face of bolt for wear and burrs.

Note. Carbines M2 and M3 are equipped with the full round bolts and firing pins (fig. 32) with the compound bevel on the upper left rear portion of the tang. These components must be used on M2 carbines and may be used in the M1 and M1A1 models.

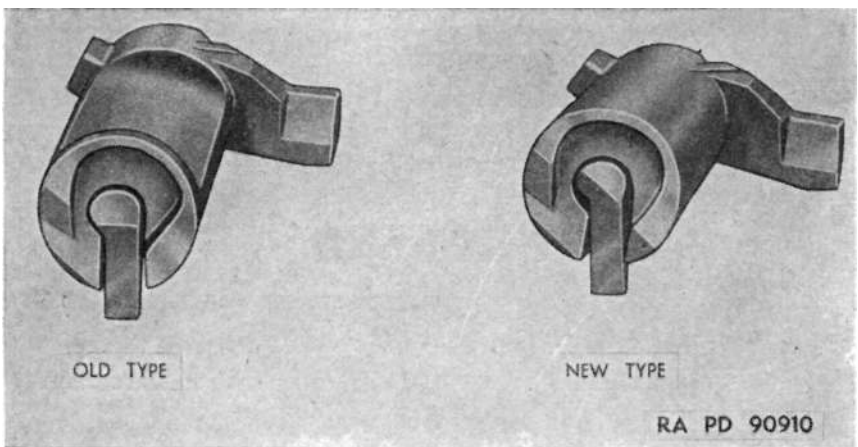

Figure 32. Bolt and firing pin — early and present manufacture.

40. Assembling

Assemble bolt in reverse order of disassembly.

Note. In assembling the bolt, take care to properly position plunger so that flat surface of plunger matches the flat surface on the extractor retaining lip.

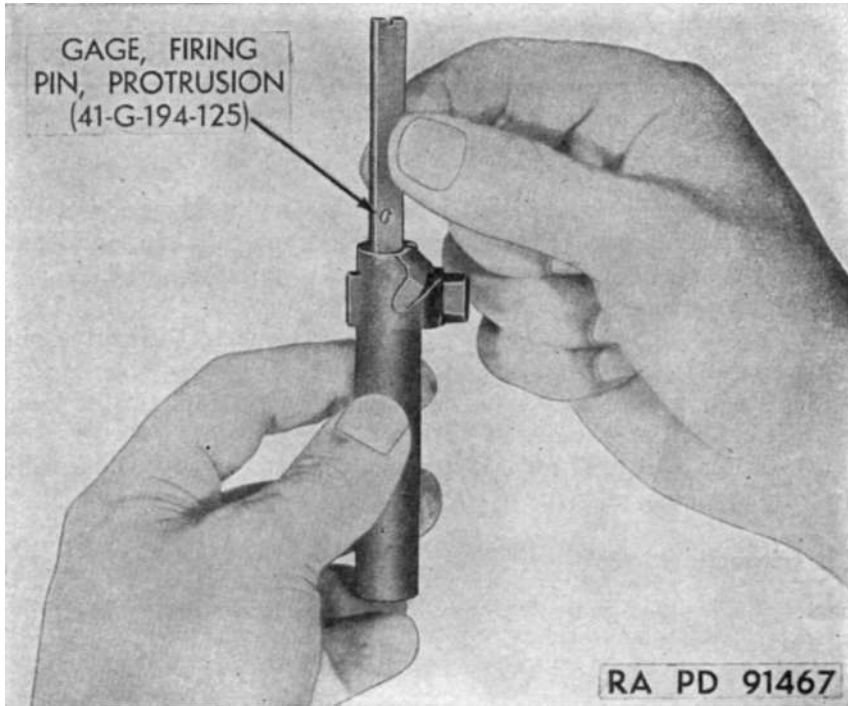

Figure 33. Gaging firing pin protrusion.

41. Functional Check

a. Test bolt for freedom of movement in its guideways in receiver. Check freedom of movement of firing pin in bolt, fit of tang in slot, and protrusion of nose of pin from face of bolt when in forward position. Firing pin should move freely in bolt. Fifth echelon organizations inspect firing pin protrusion with firing pin protrusion gauge (41-G-194-125). (See fig. 33.) Before proof or functional firing, nose of firing pin should protrude 0.048 to 0.065 inch.

b. Test functioning of extractor and ejector. When ejector is depressed, it should be flush with face of bolt. A free ejector should not extend beyond the front lip of bolt, as it is likely to cause obstruction to feeding.

SECTION VIII

FRONT SIGHT ASSEMBLY

42. Disassembly

a. Do not remove front sight unless necessary, as the body of the front sight is crimped over both ends of the front sight pin, and front sight key is staked at the rear end in its keyway in the barrel.

b. Remove the front sight as follows:

(1) Break sight pin loose, using a tapered punch, then drive pin out, using a $\frac{3}{32}$ -inch drift.

(2) Position front sight removing tool (41-T-3318-500) over front sight, hooking it on the rear of the sight. (See fig. 34.)

(3) Enter pilot of screw into end of barrel and remove front sight by turning handle of tool.

43. Inspection

Inspect blade for alignment. Check wings for deformation. Check sight for rust and shine.

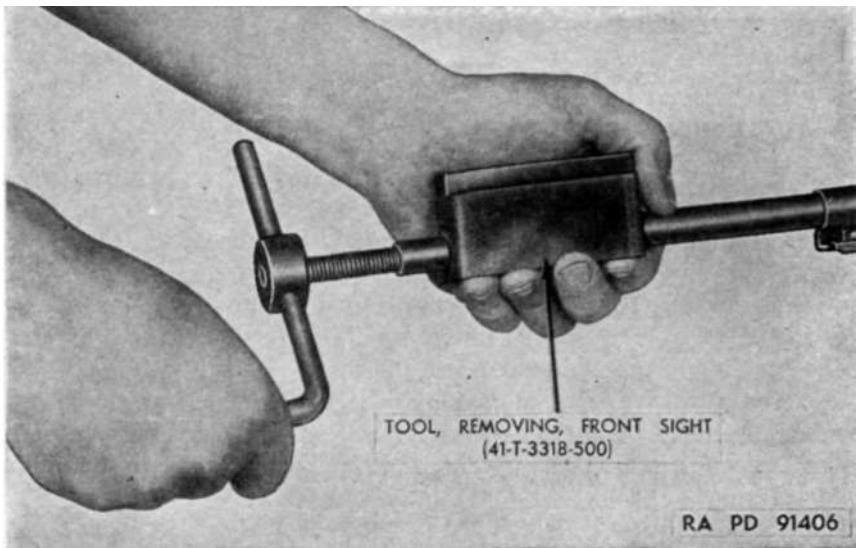

Figure 34. Removing front sight.

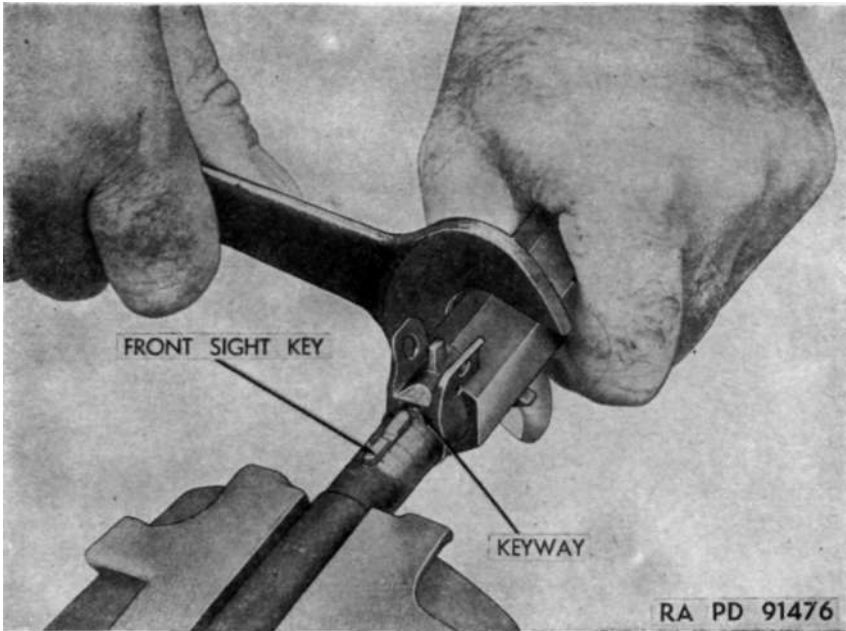

Figure 35. Aligning front sight using tool (41-T-3017-625).

44. Maintenance and Repair

Looseness of the front sight on the barrel is usually caused by a loose key which is improperly staked. The key can be tightened by tapping it forward against the front end of the keyway and then staking the rear end of the keyway firmly against the rear end of the key. If the key has side movement, replace the key or, in an emergency, peen in the keyway lightly.

45. Assembly

(The front band must be assembled on the barrel before the front sight is assembled.) Place front sight key in keyway in top of barrel at muzzle with pin notch facing up. Tap key snugly toward front end of keyway and stake rear end of keyway securely against key to hold key in position. Slide front sight on barrel with sloping faces of wings to rear. Using front sight assembling tool (41-T-3017-625) mate keyway and key in barrel (fig. 35) and drive sight on barrel (fig. 36) until pinhole in sight is in alignment with pin notch in key. Install front sight pin and stake metal of sight over both ends of pin to hold in position.

Note. The key must fit tightly in keyway. To assure this, tap sight forward after pin is inserted, and restake keyway in rear of key.

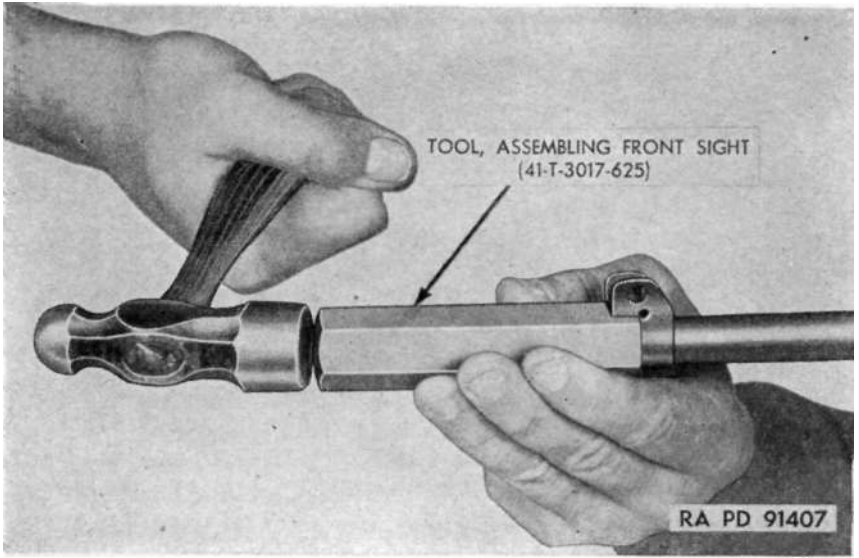

Figure 36. *Installing front sight.*

SECTION IX

REAR SIGHT ASSEMBLY

46. Disassembly

a. GENERAL. Carbines of early manufacture were equipped with an L-type rear sight, composed of two integral leaves set at right angles to each other. By rotating the leaves on the leaf pin, the sight can be set at 150-yard or 300-yard range, but it has no windage adjustment. All carbines of future manufacture will be equipped with the adjustable rear sight (D73955) or (D7160060) (fig. 6), and all L-type sights on carbines of early manufacture will be replaced by the adjustable type sight. The adjustable rear sights (D73955) and (D7160060) differ only in method of manufacture. The sight (D73955) is a machined type, and the sight (D7160060) is a stamped type. The range and windage settings, and the operation of both sights are identical.

b. L-TYPE REAR SIGHT. To remove the L-type rear sight assembly used on carbines of early manufacture, clamp rear end of receiver in a jaw protected vise. Place rear sight aligning gauge over L-type sight and make a scribe mark on rear of receiver (fig. 37), for use as an alignment mark for installing new sight. Drift the old sight out of dovetail slot from left to right, using a brass drift. (Dovetail tapers to left. The letter "S" is stamped on the left face of the base to denote small end of taper. On carbines of recent manufacture the base is staked in place).

c. ADJUSTABLE REAR SIGHT. (1) Make a scribe mark on the receiver directly opposite long line on index plate for proper alignment in assembly.

(2) Place assembling tool on the receiver with the right-hand jack screw retracted to the extreme position and out of the way. (See fig. 38.)

(3) Remove sight by placing guide of assembling tool against the side of the sight, put connector in place in dovetail guide, and tighten left-hand jack screw. When pressure becomes excessive, tap connector with a brass hammer and take up slack until sight is removed.

Note. On stamped type sights the spacer must be used to prevent distortion of sight base wings.

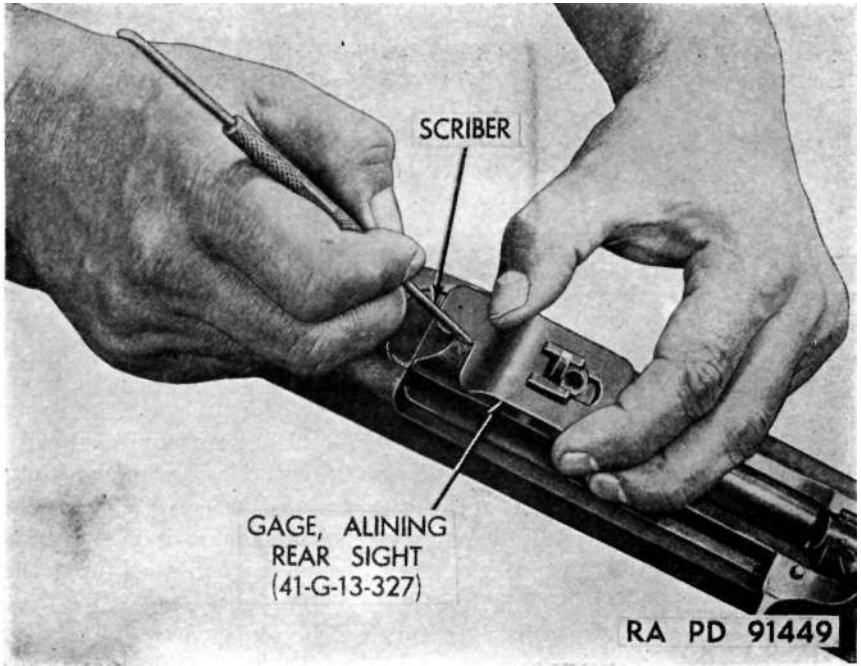

Figure 37. Scribing mark for replacement of rear sight.

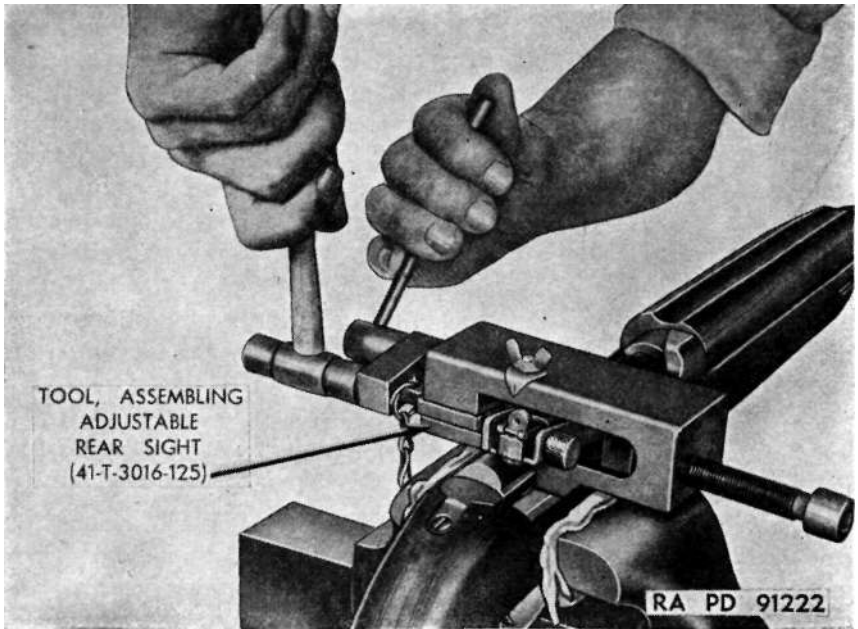

Figure 38. Removing rear sight.

47. Inspection

a. Check sight base for looseness, and bent, burred, or shiny wings. Check ramp for worn or burred guideways and index ball retention notches in floor. Check notches for foreign matter. Check index plate for security and setting.

b. Check windage screw for wear of threads, burs, security and staking, and check windage screw knob for worn knurling. With ramp centered in sight base, press windage screw knob to left and release, to test spring action of index ball on knob. There should be perceptible lateral movement of the knob, due to pressure and index spring action. When released, clearance between inner face of knob and sight base should not exceed 0.005 inch.

c. With ramp centered in sight base, attempt to move lower end of ramp from side to side. There should be practically no lateral movement. If movement is present, it indicates worn threads on either windage screw, ramp, or both. Press rear end of ramp down and release to check spring action of ramp guide plunger.

d. Move aperture slide up and down full length of ramp. Slide should move freely and be positively retained at each sight setting by the index ball. The slide should be stopped at the front (lower) end of the ramp by stakes in guideways, and at the rear (top) by the protrusion of the ramp guide plunger into the left guideway of the ramp. There should be no undue looseness of the aperture slide in the ramp guideways. Check peep hole for shine and foreign matter.

48. Maintenance and Repair

As the adjustable rear sight is expendable and replaceable as an assembly, no replacement spare parts are furnished for field repair. Check machined type sight for loose or missing index plate and screw. The sight should be kept clean and lightly oiled to prevent rusting and insure proper operation.

a. **CLEANING.** The sight is cleaned best with a small brush and clean cloths. Remove light rust with light oil. Use crocus cloth for removal of heavy rust, but since its use produces shine, exercise caution. When cleaning, move ramp and aperture slide in order to clean thoroughly under them.

b. **OILING.** Immediately after cleaning, apply a light film of oil to all exposed metal surfaces to prevent rusting. Excess oil will collect foreign matter, which will clog the sight and cause excessive wear. A small drop of oil on index balls and ramp guide plunger will lubricate and preserve these parts and their component springs. Such oiling is best done with the dropper of the oiler, or a broom straw dipped in oil. Wipe off excess oil.

Note. When cleaning the carbine, apply a small drop of oil to the aperture slide guideways in the ramp, the threads of the windage screw, the index balls, and ramp

guide plunger. Use preservative lubricating oil (special, or light) above 0° F. For temperatures below 0° F. use only preservative lubricating oil (special).

c. LOOSE SIGHT BASE. If the sight base becomes loose in the receiver, tighten it by restaking the receiver into either of the two notches in the dovetail base of the sight. If base has shifted, it should be realigned and restaked. If sight has been staked properly, it can be restaked in the same place. If necessary to restake at other than the previous points of staking, file new indents in sight base and stake receiver opposite the new indents. Make certain that points of staking are $\frac{1}{16}$ inch from edges of dovetail slot and directly opposite the indents. If staking fixture does not line up with indents in sight base, perform staking free-handed as outlined above.

49. Assembling

- a. Press new rear sight into right side of dovetail by hand.
- b. Center the aperture ramp on the sight base..
- c. If stamped type sight is being placed on receiver, place spacer attached to assembling tool in place for reinforcing the side wings of sight. (See fig. 39.)
- d. Place assembling tool on receiver with lip of assembling tool engaging operating slide guideway in receiver.

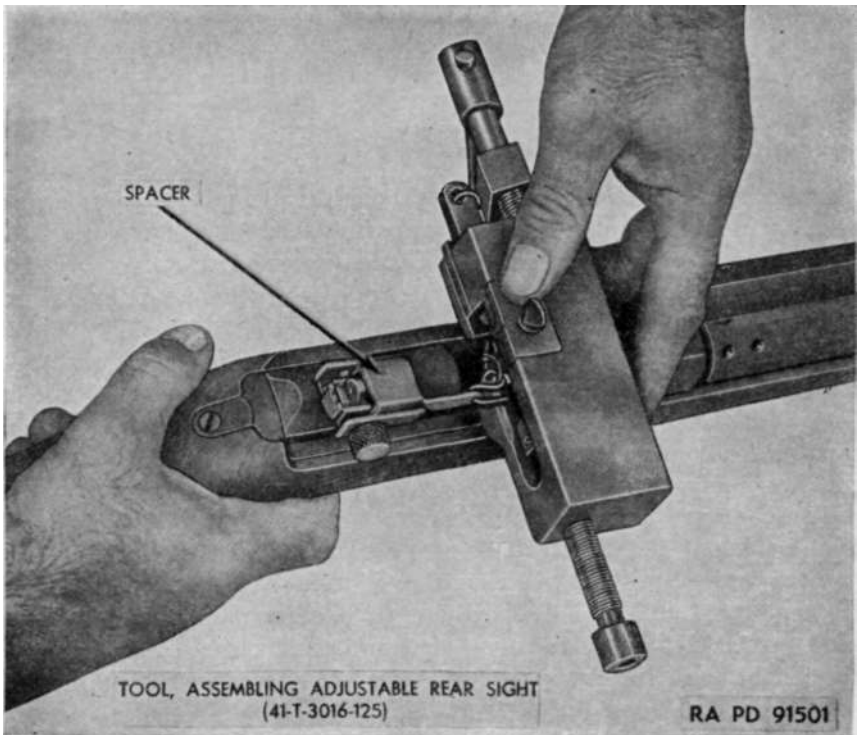

Figure 39. Rear sight assembling tool with spacer.

e. Move assembling tool to rear until dovetail guide on tool will enter dovetail slot in receiver.

f. Tighten jack screw by hand until block of jack screw is against the side of sight.

g. Insert torque wrench in jack screw.

h. Using torque wrench, move the sight into the dovetail slot.

(1) Be sure reading on torque wrench is over 18 inch-pounds.

(2) Be sure reading on torque wrench is under 54 inch-pounds.

(3) If outside the above limits, put spacer in place and remove sight.

Proceed as outlined in *v* or *w* below.

i. Continue operation in paragraph 49 above until zero line of index plate is aligned with scribe mark on rear of receiver.

Caution: Reading on torque wrench should be taken during movement of the wrench, as reading taken when starting the wrench will be high, due to starting torque in moving jack screw.

j. Remove the tool from the receiver.

k. Screw ramp of sight to extreme left.

l. Place staking fixture in place as follows:

(1) When staking machine type sight, have fixture firmly against forward edge of sight base wings.

(2) When staking stamped type sight, have center leg of fixture firmly against windage screw.

m. Place staking punch in hole in fixture and rap lightly with hammer, holding punch to rear to be sure fixture is in proper position. If points of staking are not directly opposite indents, perform staking operation as outlined in step (2) below.

Note. Points of staking are indicated by notches or indents on sight base dovetail. Stake only adjacent these notches. Metal should flow into indents in sight dovetail. (See fig. 40.)

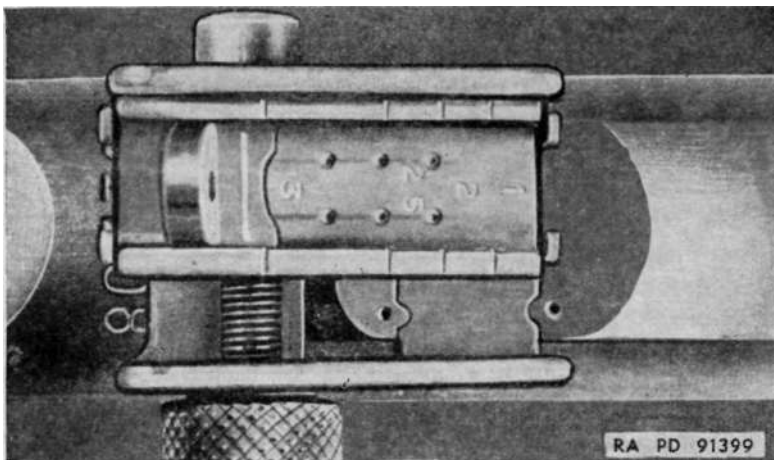

Figure 40. Rear sight showing staking.

(1) The staking operation is extremely critical and the success of such an operation will depend largely upon the individual skill and judgment of the operator. Many problems will arise which will have to be solved by individuals performing the modification. A few of the problems to be expected and their suggested remedies are listed in the following subparagraphs.

(2) Horizontal misalignment of indents on sight base dovetail with references to holes in staking fixture.

Remedy: Using the staking fixtures as a guide or template, check alignment of indents. If the indents are slightly out of horizontal alignment they may be corrected by enlarging the indents very slightly with a small three-square file.

n. Keep screws on assembling tool well oiled.

o. Resharpen staking punches to 90° to 120° sharp points.

p. Never apply pressure to sight base wings. Sight base wings provide bearings for windage screw and any distortion will ruin sight.

q. Care in staking of the rear sight should be vigorously emphasized, as improper staking will render it impossible to fit a new rear sight on the carbine at a future date should the sight be damaged and in need of replacement. Study carefully and follow the illustration regarding the proper type of staking operation. The upper sharp edges of the dovetail slot on the carbine are easily sheared and such a shearing action will ultimately result in an unserviceable weapon.

r. On the machined type adjustable rear sight the index plate is held in place by a small screw. On some of these sights the screw is staked in such a manner as to prevent its removal. Take care, when zeroing the rifle by a movement of the index plate, to loosen the screw only enough to permit movement of the index plate.

s. Exercise great care during the procedure outlined in *h* above, as the dovetail base of the sight is hardened as well as the dovetail slot in the receiver. Because of this hardening of both of the mating parts, it is necessary that the load limits, as prescribed and as indicated on the torque wrench, be rigidly maintained. If too great a pressure is exerted in the placement of the sight, the receiver of the carbine will crack or break; and if too light a pressure is exerted, the sights will work loose under the shock of firing.

t. The zeroing plate on the stamped type sight is directly below the ramp and in the center rear portion of the sight base. Move this zeroing plate with a small drift to prevent damage to any of the components of the sight and weapon.

Note. If sights when received are packed in light oil, do not degrease. If sights are packed in heavy oil, degrease only with dry cleaning solvent; do not vapor degrease.

u. Sometimes sufficient material is not available on the receiver to permit an adequate staking job. This is particularly true when the sight is moved to one of its extreme positions. In this case, the pro-

cedure outlined in *m* above should be followed and new indents made to permit adequate staking.

v. Sometimes a dovetail slot in the receiver may be too big to receive any sights available. In such cases, where less than 18 pounds pressure is required indent the area in front of the dovetail slot. This can best be done by using a large steel drift, placing the drift in the location shown in figure 41, and rapping the drift with a hammer. Undertake this operation with extreme caution. A blow only hard enough to cause a flow of metal into the dovetail slot is necessary.

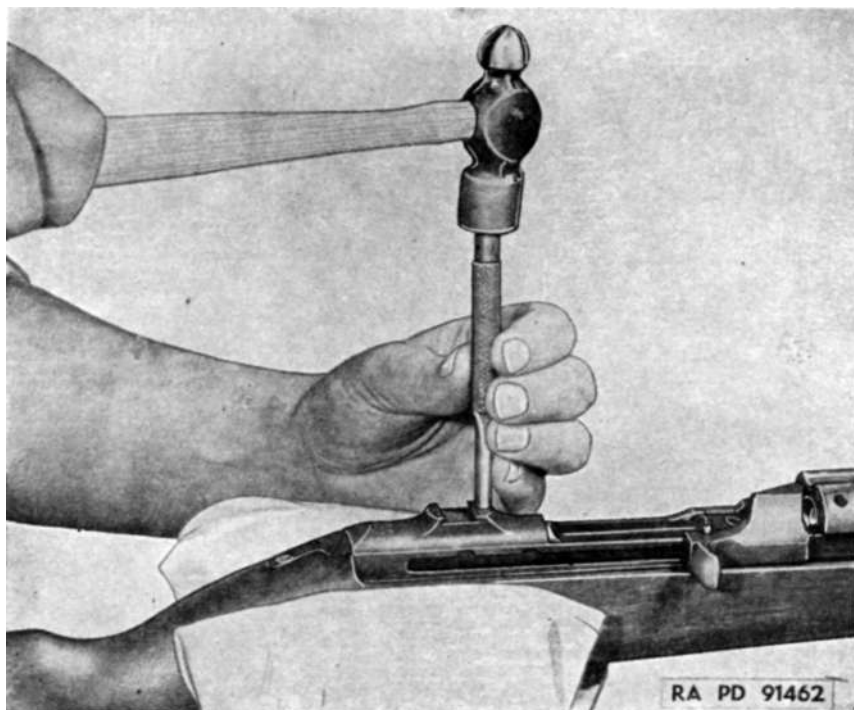

Figure 41. Peening receiver to reduce oversize dovetail dot.

w. When the sight requires more than 54 inch-pounds pressure to assemble it to the receiver, remove the sight assembly and file the bottom of the sight base as shown in figure 42. Do not attempt to file the edges of the sight base, and under no circumstances should the receiver be filed.

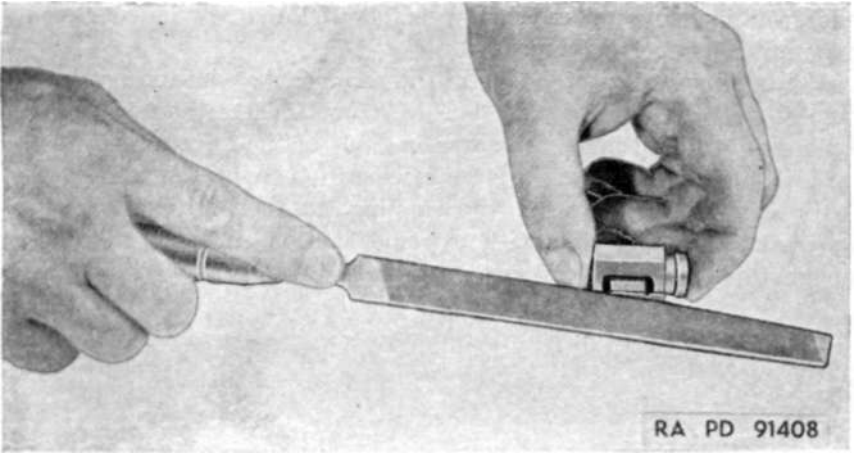

Figure 42. Filing rear sight base to fit undersize dovetail slot.

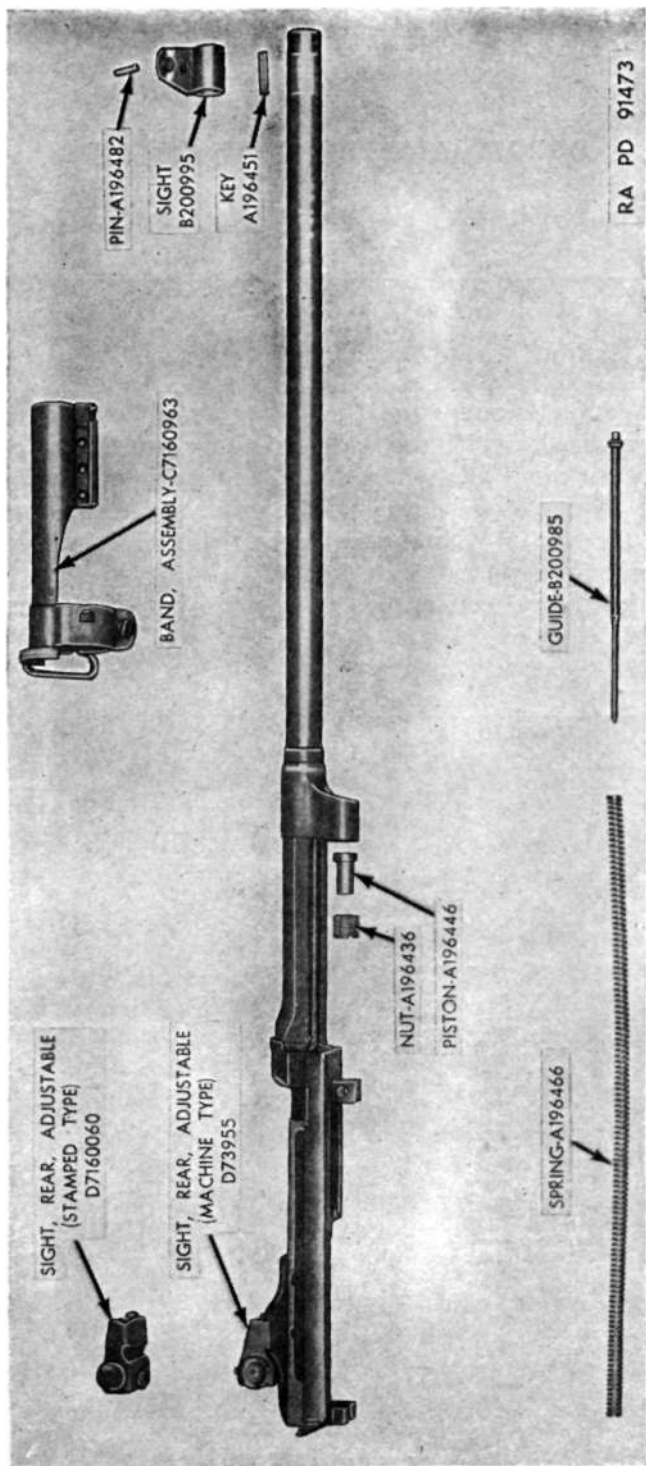

Figure 43. Barrel and receiver group parts.

SECTION X

BARREL AND RECEIVER GROUP

50. Disassembly (fig. 43).

a. REMOVING BARREL FROM RECEIVER. DO not remove the barrel from the receiver except for replacement of a new barrel. Completely disassemble all components from barrel and receiver. Place barrel in jaw protected vise. Allow enough of the rear end of the barrel to project from the vise to permit the receiver wrench (41-W-1998-765) (fig. 44) or early style wrench (41-W-1998-750) (fig. 45) to be positioned over front of receiver. Place wrench over receiver near barrel and unscrew counter-clockwise.



Figure 44. Removing barrel from receiver.

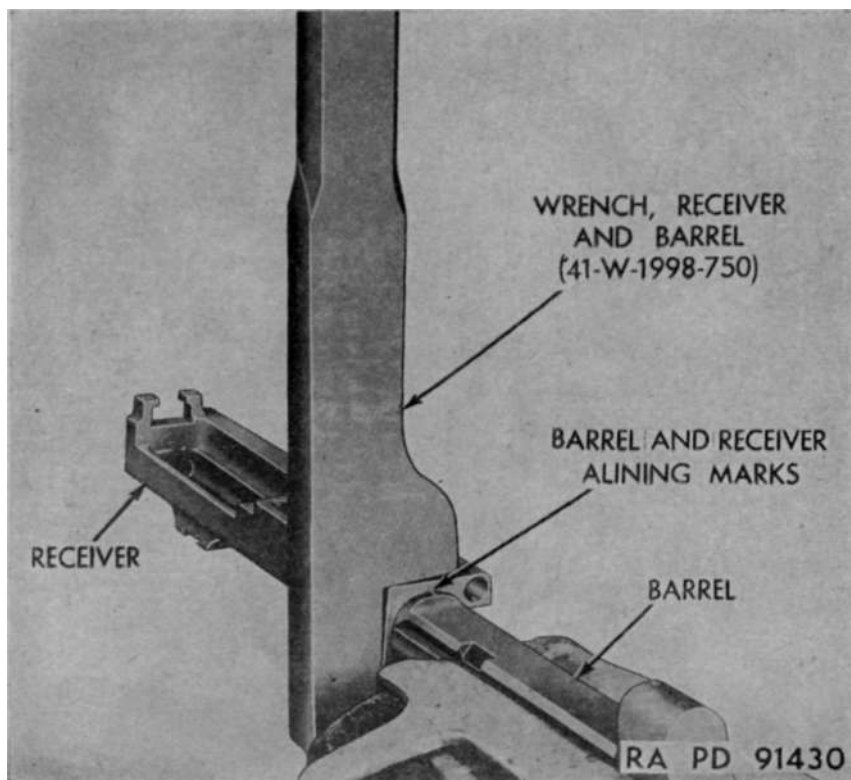

Figure 45. Removing or replacing barrel.

b. REMOVING GAS PISTON AND PISTON NUT. (1) The gas piston and piston nut are the only removable parts of the gas cylinder group. To remove piston, clamp barrel firmly in a vise with protected jaws and, using the gas piston nut removing tool M5, or gas piston holder and spanner wrench, unscrew the piston nut from gas cylinder. (See fig. 46.) Be careful not to bur or twist prongs on nut when removing (nut is staked in place) or piston will not move freely. (If piston nut or piston is tight, proceed as explained in par. 52a. Remove nut, elevate muzzle of barrel, and slide piston out of gas cylinder. If piston will not slide out, tap cylinder lightly with wooden block.

(2) The gas cylinder may be integral with the barrel, or swaged on the barrel at manufacture. Do not remove the gas cylinder. If gas cylinder is unserviceable, send weapon to base shop for replacement of barrel assembly.

51. Inspection

a. GENERAL. Check assembly of barrel to receiver. Screw barrel into receiver tightly, with draw marks aligned. In this position, gas cylinder should be centrally located with regard to lower face of re-

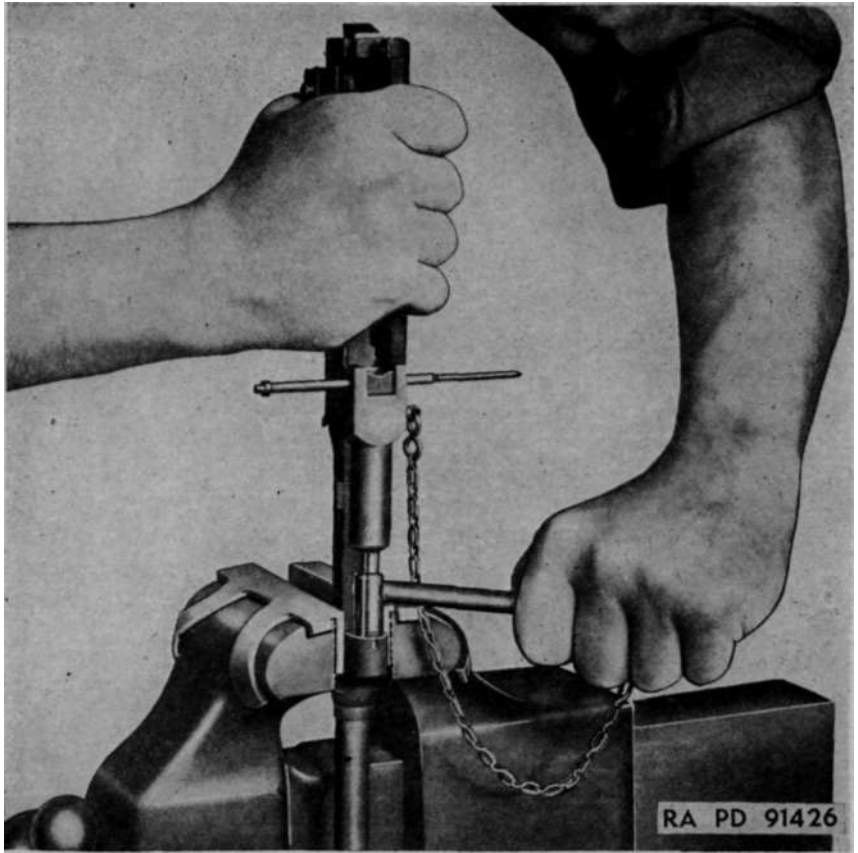

Figure 46. Removing piston nut from gas cylinder.

ceiver, operating slide guideways symmetrically located with regard to centerline of receiver, and extractor should not bind when bolt is assembled to weapon and operated. If extractor binds when barrel is in proper alignment, a damaged extractor is indicated. Check for parallelism between barrel and receiver, as explained in paragraph 52c.

b. GAS CYLINDER. (1) Inspect gas cylinder for looseness (swaged on type), deformation, piston wear, burs, carbon, and rust. Inspect piston nut threads for wear and burs. Inspect gas port for foreign matter, using a 0.070-inch drill inserted by hand.

(2) Inspect piston for wear, burs, and carbon.

(3) Inspect piston nut for loose fit in gas cylinder. Inspect threads and turning lugs for wear and burs. Inspect piston aperture for burs. Piston should be an easy fit in aperture and extend, when in the rearward position, 0.175 (approximately $\frac{11}{64}$) inch from the rear face of the nut. In forward position, piston should clear nut approximately

$\frac{1}{32}$ inch. When assembled, the gas cylinder should be staked very lightly into the nut in one of the three places provided, or nut may work loose during firing of the carbine.

c. BARREL. Inspect barrel for general appearance and serviceability.

(1) *General inspection.* Inspect barrel for deformation, alignment with receiver, and for rust, corrosion, and burs. Inspect gas port for foreign matter, and inspect extractor cut in rear face for burs and foreign matter. Inspect operating slide guideways for excessive wear, burs, and foreign matter. Burred or damaged muzzle end causes inaccuracy.

(2) *Inspection for serviceability.* (a) Inspection of barrel for serviceability is based principally upon accuracy, and inspectors are guided by this requirement. Accuracy is reduced in varying degrees by the following defects: bulges, erosion, and pits (see fig. 19). Before a barrel is inspected for serviceability, fouling and oil should be removed and the bore wiped dry.

(b) Place barrel reflector in the chamber and examine the bore from the muzzle and breech. If no barrel reflector is available, place piece of white paper or rag in receiver and hold barrel so that light is reflected into chamber and bore.

(c) If the barrel is not bent or otherwise deformed, the bore appears free from bulges and pits, and the lands are sharp and uniformly distinct, it is serviceable.

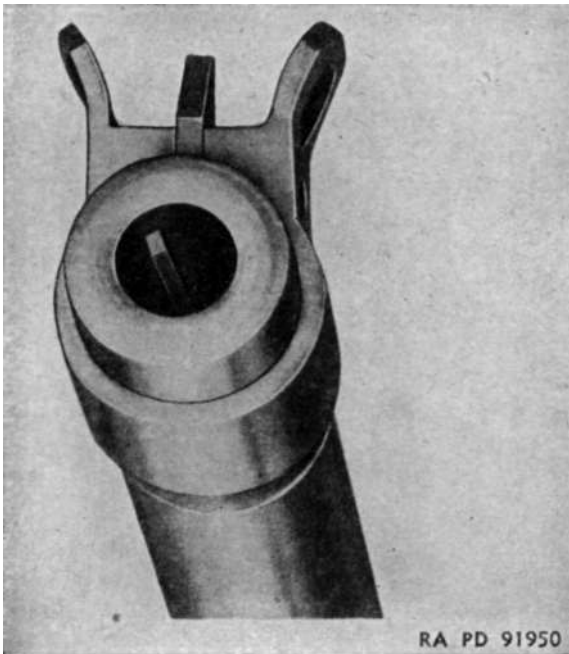

Figure 47. Muzzle end of barrel showing counterbore.

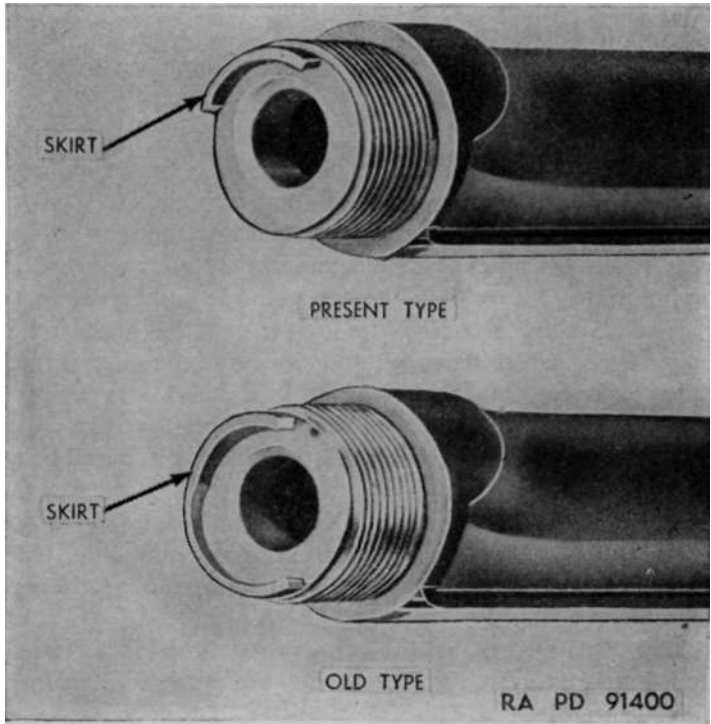

Figure 48. Chamber end of barrel showing old and new type skirts.

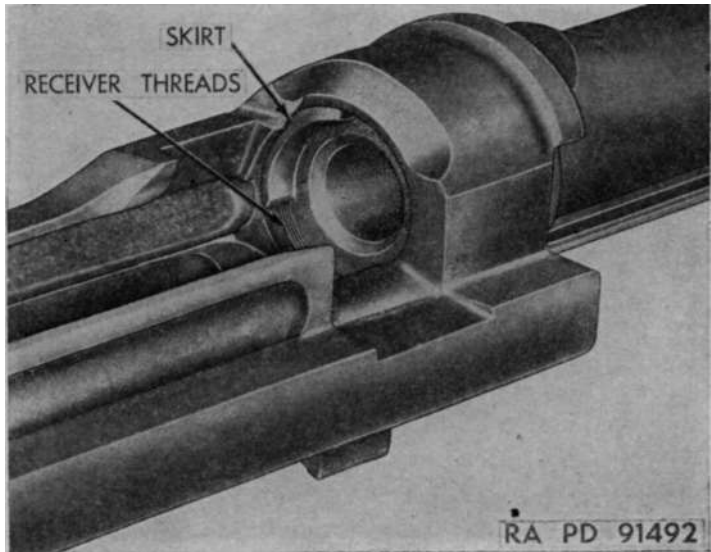

Figure 49. Breech end of barrel showing new type skirt.

(d) If the bore contains small pits but has sharp and uniform distinct lands, is free from bulges, and is not otherwise deformed, it is serviceable.

(e) If the barrel contains a bulge, it is unserviceable. This condition is indicated by a shadowy depression or dark ring in the bore, and may often be noticed through a bulge or raised ring on the barrel surface.

(f) If the barrel is pitted to such an extent that the sharpness of the lands is affected, or if it has a pit or pits in the lands or grooves large enough to permit the passage of gas past the bullet (a pit the width of a land or groove and $\frac{3}{8}$ -inch long or longer), it is too inaccurate for serviceability and should be scrapped. This condition indicates that proper care of the barrel has not been taken.

(g) During the inspection of the bore from the breech, give special attention to the chamber. Pits will cause hard extraction and may cause the cartridge case to stick in the chamber sufficiently to cause failure to extract. Barrels with chambers having pits large enough to cause cartridges to stick are unserviceable.

(h) If the bore at the muzzle is enlarged, improper cleaning is indicated. Such wear is usually due to rubbing of the cleaning rod in the muzzle when carelessly used.

Note. In some weapons however, the last quarter inch of the bore at the muzzle end of the barrel has been counterbored. This counterbore improves the accuracy of the carbine, and is intended to eliminate tool marks, nicks, and burs in the muzzle end of the barrel. This counterbore should not be confused with an enlarged bore at the muzzle end.

(i) Barrels of current manufacture have been modified by the elimination of a portion of the skirt (fig. 48) on the chamber end. In barrels of early manufacture, this skirt was extended around approximately two-thirds of the chamber end of the barrel and was thickened somewhat in its center section. As the thin section of the skirt served no useful purpose it was eliminated and only the thickened portion remained. When looking into the breech end of the gun ahead of the bullet ramp, the thread of the receiver can be seen. (See fig. 49.) This is a normal condition.

d. RECEIVER. (1) Inspect receiver for looseness with barrel, deformation, rust, and burs. If receiver is disassembled from barrel, inspect for worn or crossed threads in barrel aperture.

(2) Inspect bolt guideway and locking shoulders for wear, burs, cracks, and foreign matter. Inspect receiver retaining lug on rear end (fig. 50) for wear, burs, and looseness with recoil plate when assembled to stock.

(3) Inspect operating slide guideway on right side for wear, burs, and foreign matter, and operating slide removal cut for wear and burs. Inspect operating slide stop detent aperture for wear, burs, and foreign matter. Forward surface of aperture should be at a sharp right angle to receiver, and with a clean edge to facilitate retention of stop, and

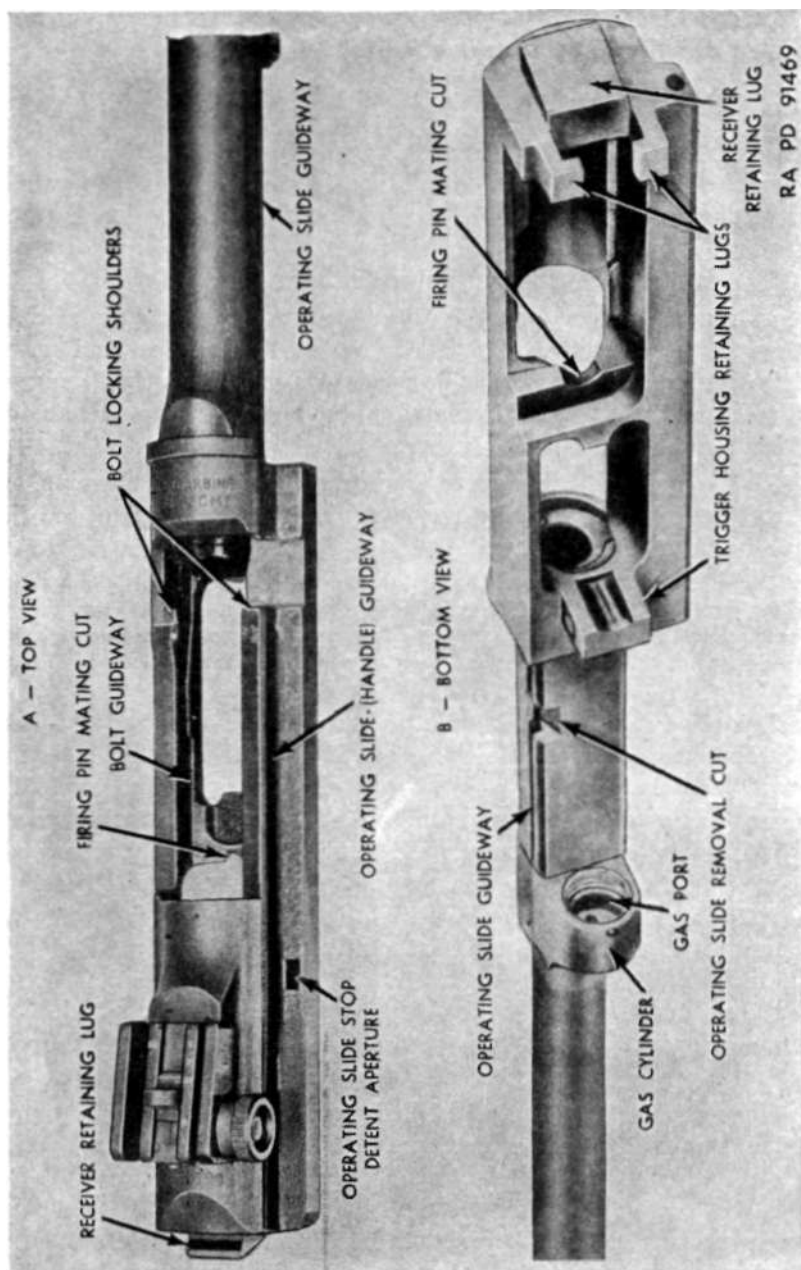

Figure 50. Barrel and receiver group.

rear face smooth and sloping to facilitate camming. Inspect firing pin mating cut in bridge of receiver for burs, and rear inside face of receiver for foreign matter.

(4) Inspect operating slide spring housing groove or spring well ("alternate" design receiver) for rust and foreign matter. Check both spring housing retainer hole in rear end of bed groove and spring housing alignment protrusion for burs.

(5) Inspect M1 and M2 receivers for run-out (drill breaking through to the bottom and right-hand side of the receiver). Receivers have been accepted in which this run-out occurred if the break-through was properly cleaned by a $1/8$ to $3/16$ inch diameter end milling operation to eliminate all feather edges. All such cleaning operations must take place at a point well behind the right locking lug surface (break-through closer than 3 inches from the front of the receiver is not permitted).

52. Maintenance and Repair

a. FROZEN PISTON NUT OR PISTON. (1) *Piston nut*. Due to heat of barrel, and hot gas entering the gas cylinder, the piston nut may become "frozen" in the gas cylinder, making removal difficult. If nut does not loosen readily, clamp gas cylinder in a jaw-protected vise so that cylinder is firmly held with the piston nut pointing up. Then unscrew nut counterclockwise, using cylinder holder and spanner wrench (41-H-2373) (fig. 46), exercising care to hold the tool in close engagement with the nut when turning. If tool is held loosely and thus allowed to slip out of engagement repeatedly, the lugs on the nut or tool will become worn and make removal difficult. If nut will not loosen as above, soak with preservative lubricating oil (light) for about an hour to loosen binding. Oil can be dropped through gas port drill hole in gas cylinder.

(2) *Chasing gas cylinder threads*. Chase threads of the gas cylinder, using gas cylinder tap, 1T2-32NS3 (41-T-336-900). (See fig. 51.) Dip tap in a suitable cutting oil and start tap carefully in gas cylinder. Cut threads a little at a time, using a forward and backward movement. Exercise care to stop tap as soon as it touches bottom to prevent damaging tap or cylinder. Remove tap and thoroughly clean chamber.

(3) *Piston*. If piston becomes "frozen" in the gas cylinder due to carbon or rust, soak with preservative lubricating oil (light) for about an hour and then work out of cylinder. A small prick punch or needle-nosed pliers can be used through the outside gas port hole in cylinder. When removed, clean gas cylinder and piston thoroughly, polish and oil lightly, and reassemble. Be sure to stake gas cylinder lightly into one of the notches in the nut when reassembling.

b. CARBON AND RUST. (1) *Carbon*. Because of the rearward position of the gas port and high gas pressure encountered there, excessive carbonization of cylinder and piston is unlikely. However, these parts

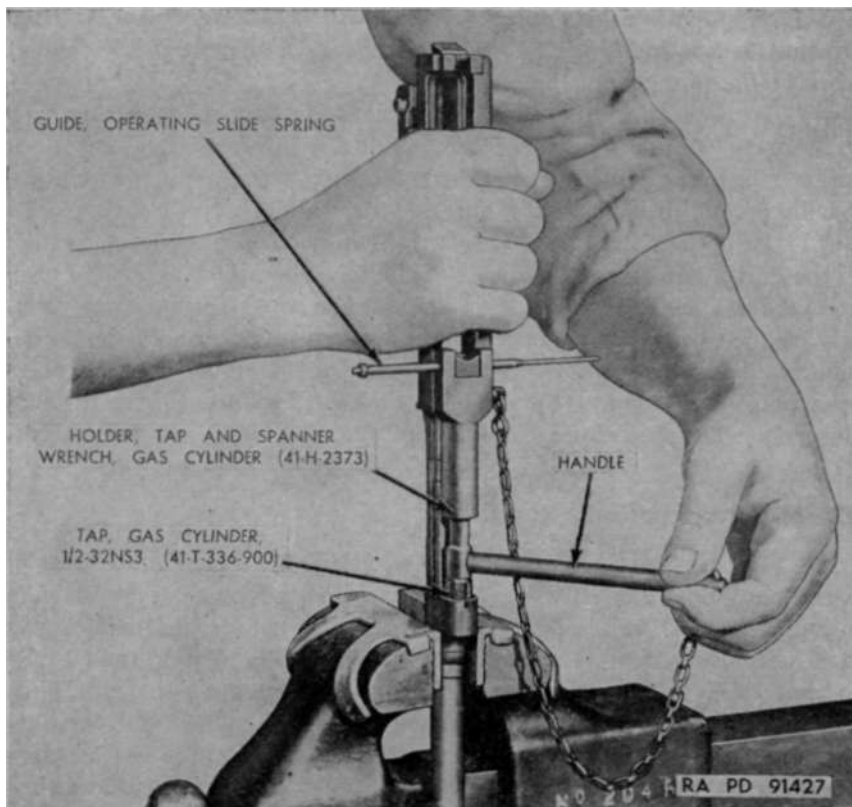

Figure 51. Chasing gas cylinder thread.

should be cleaned at intervals, or when fouling or sticking of piston is evident, and gas port in barrel inspected and cleaned if necessary. Remove piston nut and piston from gas cylinder and scrape excess carbon off with flat blade. Take care not to scratch parts unnecessarily. When carbon has been removed, clean inside of cylinder and piston, oil very lightly, and replace. Clean gas port with an 0.070-inch or smaller drill inserted by hand, or with piece of soft wire or similar instrument. Be sure to stake piston nut lightly in place when assembling.

(2) *Rust.* Rust is more likely to form on surfaces not regularly lubricated, or where barrel heat dissipates oil film rapidly. Such points are: under side of barrel, body of oiler beneath sling, receiver locking lug recess in recoil plate, operating slide spring, well in receiver ("alternate" design receiver) or spring housing tube, rear sight base, inside faces of operating slide, recesses in trigger housing, and like unexposed recesses and faces. Remove rust with a rag saturated with rifle bore cleaner or light, preservative lubricating oil (special) or by using crocus cloth, but exercise care to avoid scratching surfaces. After rust is removed, wipe surface with clean, dry cloth and then with clean cloth

lightly saturated with preservative lubricating oil (special). The operating slide spring housing (or tube) may be cleaned with the carbine cleaning rod and small patch. Be sure rear end of tube is clean.

c. REPLACING UNSERVICEABLE BARREL. (1) Replace barrel if it is bent or damaged, or if the headspace is excessive.

(2) Clamp the barrel in the vise as shown, apply special wrench (41-W-1998-765) to receiver close to the barrel, and unscrew the receiver counterclockwise. (See fig. 44).

Note. The old wrench (41-W-1998-750) is to be used until stock is exhausted.

(3) Select proper barrel and receiver combination so about $\frac{1}{16}$ -inch draw is obtained when assembled. Screw the receiver on the barrel with special wrench (41-W-1998-765); draw up receiver until draw line on receiver (fig. 52) coincides with line on barrel. Flat surfaces on bottom of barrel and receiver must be parallel. Check this by placing two bars, about 10 inches long, in position as illustrated in figure 53, and sight over the edges. When the two bars lie parallel, the barrel and receiver are in exact alignment for proper functioning.

Note. After installing barrel on receiver, check the headspace as shown in figure 54.

d. CHECKING CHAMBER FOR PROPER HEADSPACE. If after rebarreling, there is insufficient headspace indicated by the bolt failing to close on the 1.290 headspace gauge (41-G-199-175), the chamber must

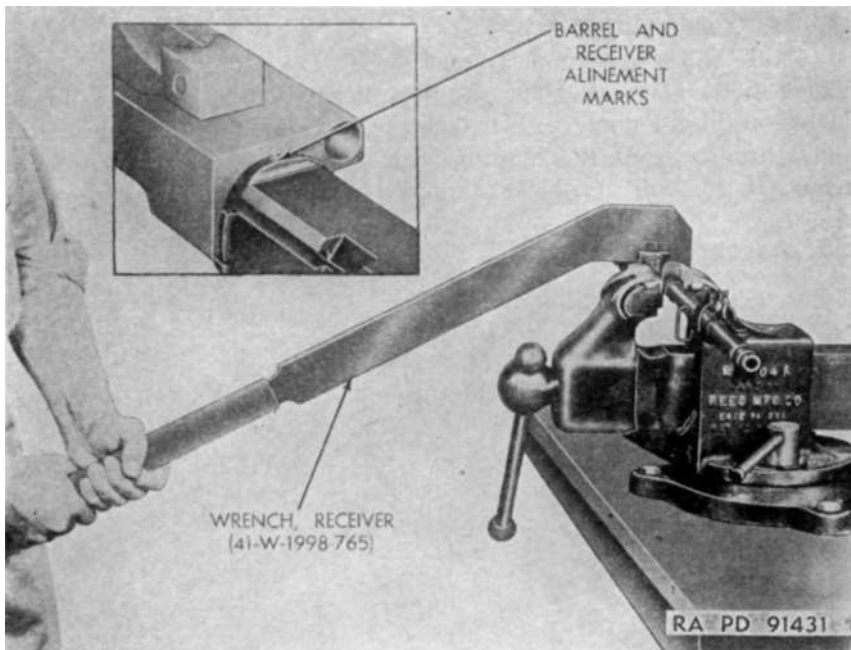

Figure 52. Assembling barrel to receiver.

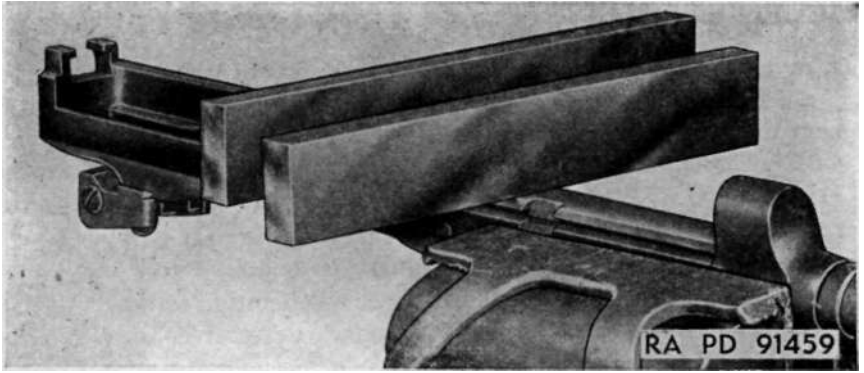

Figure 53. Checking barrel and receiver alignment.

be reamed with carbine reamer (41-R-488-125). To correct insufficient headspace, proceed in the following manner:

(1) Dip reamer in lard oil and place in chamber through top opening of receiver. (See fig. 55.) Turning handle slowly to the right, remove only sufficient metal to permit bolt to close on 1.290-inch headspace gauge (41-G-199-175).

(2) Wash chips from reamer with lard oil after removing from chamber.

(3) Handle reamer with care to prevent it from being chipped or nicked. Never turn reamer backwards in chamber, as this tends to dull the cutting edges.

(4) If bolt closes properly on the GO gauge (1.290), the NO GO gauge 1.300 (41-G-199-200) is then inserted. The bolt should not close on the 1.300 gauge. If bolt does lock completely, it indicates too much headspace. In this case, use a maximum bolt and try the gauge again. If this bolt also locks completely, the receiver is not usable.

53. Assembling

Refer to paragraph 52c.

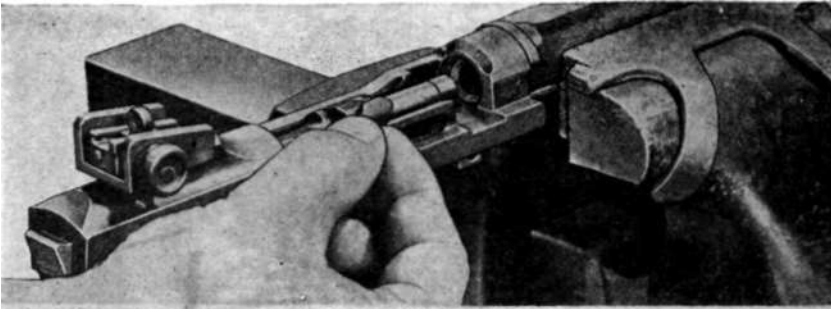

A-HEADSPACE GAGE PLACED IN FACE OF BOLT

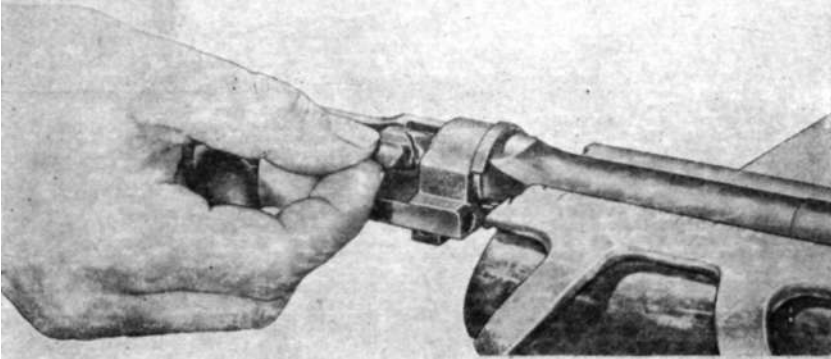

B-BOLT NOT CLOSING ON 1.300 (NO-GO) GAGE

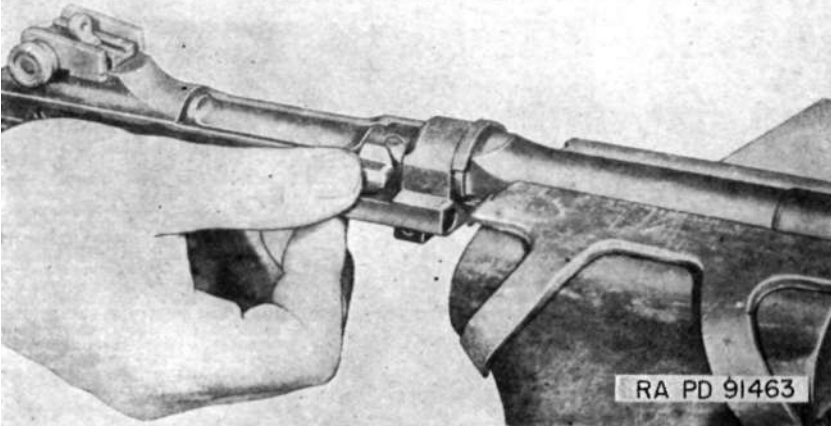

C-BOLT CLOSING ON 1.290 (GO) GAGE

Figure 54. Checking headspace.

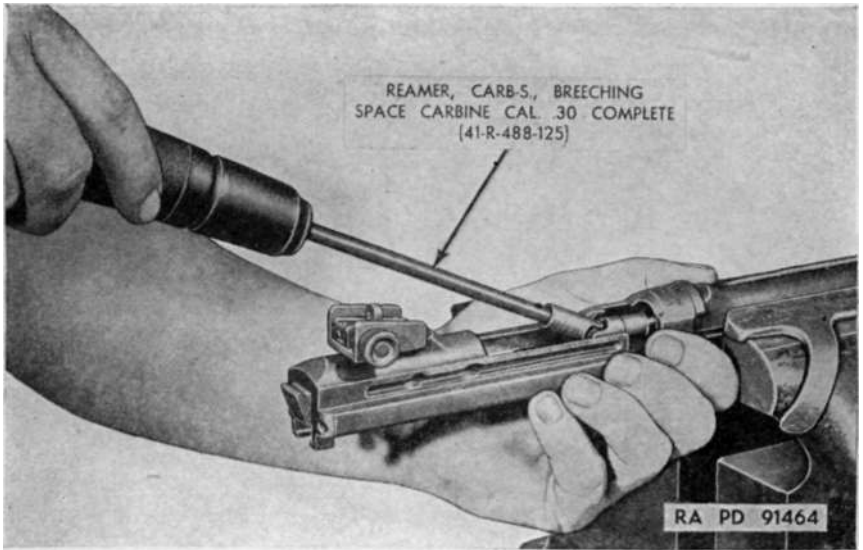

Figure 55. Reaming chamber for headspace.

SECTION XI

STOCK GROUP

54. Disassembly

a. FRONT BAND LOCKING SPRING. Insert small, straight punch in spring spindle hole in left side of forward end of stock and drive out front band locking spring part way, from left to right; then rotate spring and pull from hole. (See fig. 56.)

b. RECOIL PLATE (M1 AND M2). (1) Unscrew recoil plate screw counterclockwise until clear of escutcheon threads (above $\frac{3}{4}$ inch), then withdraw from stock and recoil plate.

(2) Loosen recoil plate by tapping lightly on rear top face with a metal tool. Pull plate directly forward out of seating recess in stock. Do not pull up or down, because rear seating lug on plate seats in a horizontal recess cut in the stock.

(3) Do not remove the escutcheon from the stock except for replacement. To remove, thread recoil plate screw all the way into escutcheon from the under side and pull escutcheon out of stock. If withdrawal is difficult, insert small straight punch from top of screw hole in stock and tap end of screw lightly to loosen escutcheon, or thread screw in from top, part way, and tap lightly; then proceed as above.

c. BUTT PLATE (EXCEPT M1A1). Unscrew butt plate screw counterclockwise and remove from stock. Loosen butt plate by tapping it lightly. Pull to rear off stock. If butt plate is tight, do not pry off, as stock is likely to be damaged. Tap on edges lightly all the way around, until loose enough to pull from stock.

d. HAND GUARD. The liner of the hand guard assembly is riveted to the hand guard; do not remove it.

e. STOCK EXTENSION (M1A1) (fig. 57). (1) Remove lower hinge screw from lower end of stock grip by turning counterclockwise.

(2) With stock extension in extended position, unscrew the hinge screw projecting from the upper face of the recoil plate cap, by turning counterclockwise. When screw is disengaged from the lower hinge nut, pull screw up and out of grip, and then lift off recoil plate cap and lower hinge. (See fig. 58.)

(3) With flat-ended punch, push hinge screw spacer out of hole in the lock on end of lower bar, up into coil spring. Then pull stock extension to rear from stock and remove grip spring, hinge screw spacer,

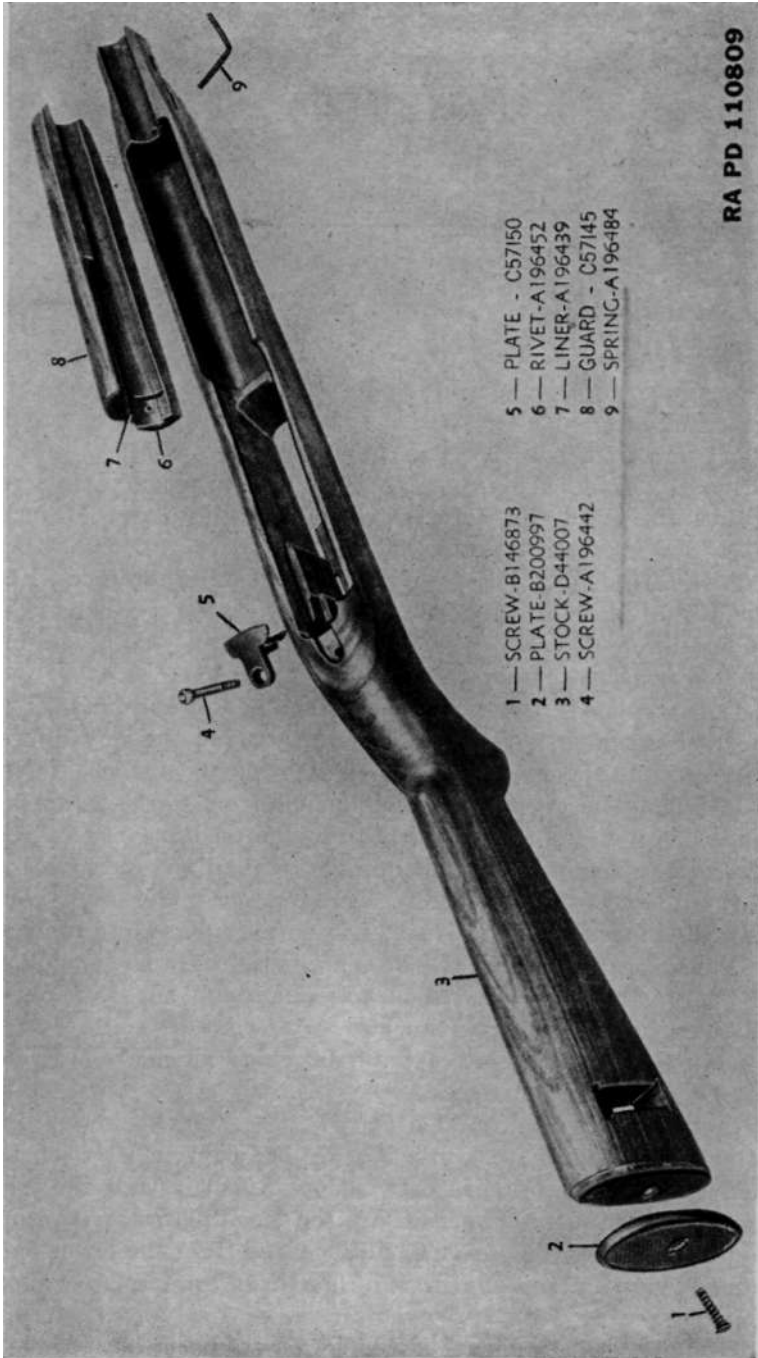

Figure 56. Stock and hand guard.

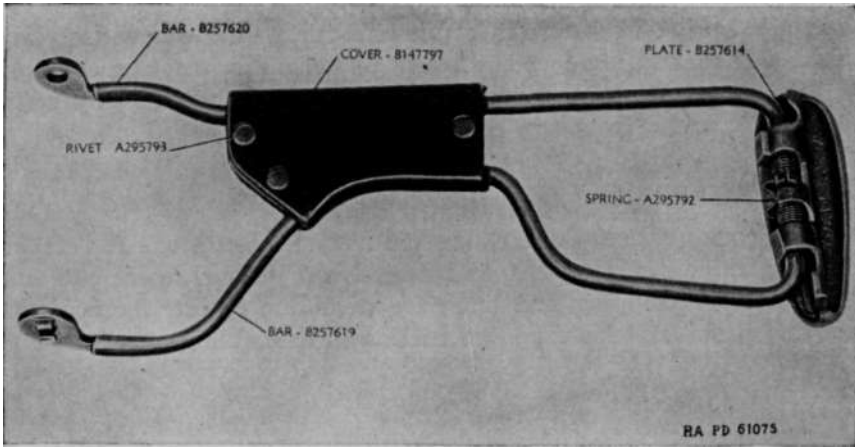

Figure 57. Stock extension — carbine, cal. .30, M1A1.

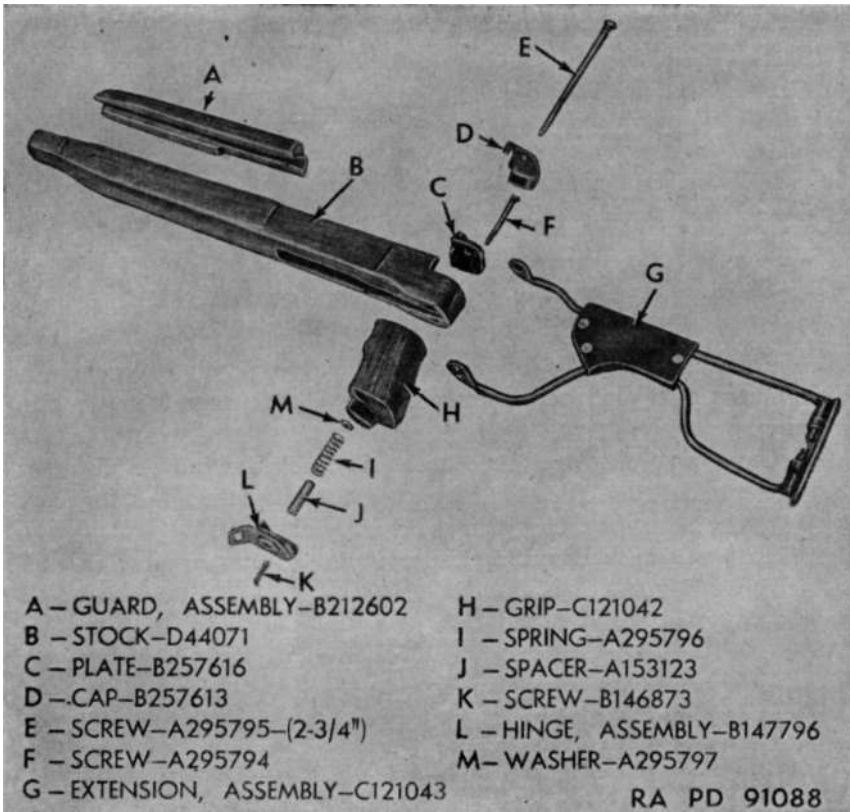

Figure 58. Stock extension group parts — carbine, cal. .30, M1A1.

and grip spring washer from countersunk hole in lower end of grip. Take care that spring does not fly out or washer does not become lost.

(4) Remove grip and recoil plate by unscrewing the grip screw counterclockwise from top of recoil plate.

55. Inspection

a. STOCK (EXCEPT M1A1) (fig. 59). (1) Inspect stock for cracks, scoring, chipping, blemishes, and excessive dryness. Inspect cuts and apertures for chipping and burs, for wear due to interference with moving parts, and for excessive friction in assembling.

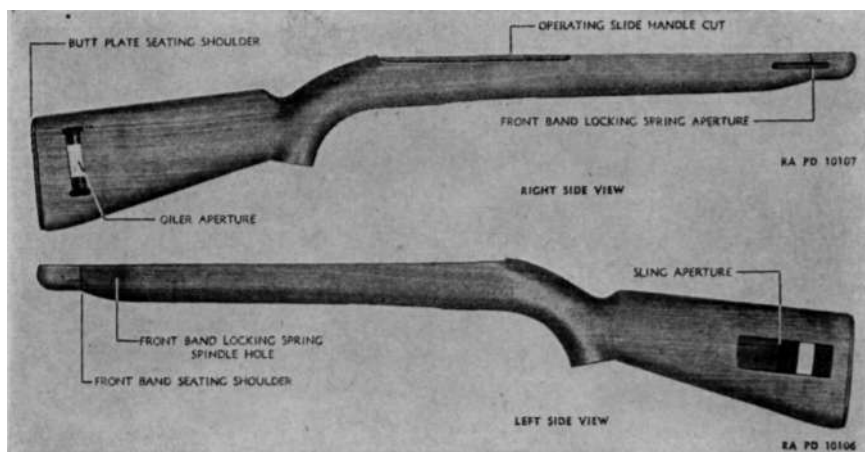

Figure 59. Stock showing apertures — carbines, cal. .30, M1.

(2) Inspect butt plate for deformation, burs, fit, and looseness on stock. Check butt plate screw for looseness. Check threads in stock for stripping.

(3) Inspect recoil plate for looseness in stock, for burs, and for excessive wear and rust. (See fig. 56.) Check recoil plate screw for looseness in escutcheon (fig. 60), burs, and worn threads.

(4) Inspect escutcheon for looseness in stock, burs, or worn threads.

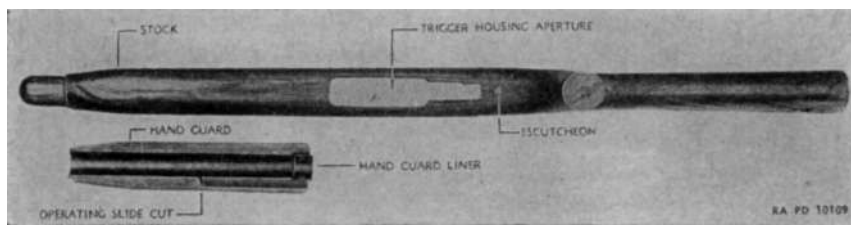

Figure 60. Stock and hand guard — carbine, cal. .30, M1.

(5) Inspect front band locking spring for deformation and excessive wear of locking shoulder. Rear face of shoulder should be square enough to retain front band in position. (See fig. 56.)

b. HAND GUARD. Inspect hand guard for cracks, chipping, and excessive wear at front band shoulder. Check hand guard liner for deformation, looseness on hand guard, defective riveting, rust, and burrs.

c. STOCK (M1A1) (figs. 61 and 62.) (1) Inspect hand guard and parts common with M1 stock, as prescribed in *b* above.

(2) Inspect grip for looseness on stock and for cracks. Grip should be rigid with stock and no twist should be possible when assembled.

(3) Inspect stock extension for smoothness of hinge action and positive locking when extended and when folded. The extension should be rigid and without shake when extended with butt plate rigidly at right angles to the bars. When swung to the left, the lock should cam out of the slot in the locking nut, and the extension should pivot smoothly about the hinge screw through an arc of approximately 180° to lie flat against the left side of the stock. When the extension is pressed flat to the stock, the lock should slip into the slot in the locking nut and the butt plate should pivot on the bar ends, so that the extension will lie locked close to the stock without looseness or shake. If shake is present in either position, a worn locking lug or locking nut, a loose hinge screw, or a broken hinge spring is indicated. If pivoting is jerky, or binding is apparent, burrs on locking lug or in slot of locking nut or bent bars are indicated. If butt plate is loose on bars or fails to pivot under spring tension, burrs or a damaged butt plate spring are indicated.

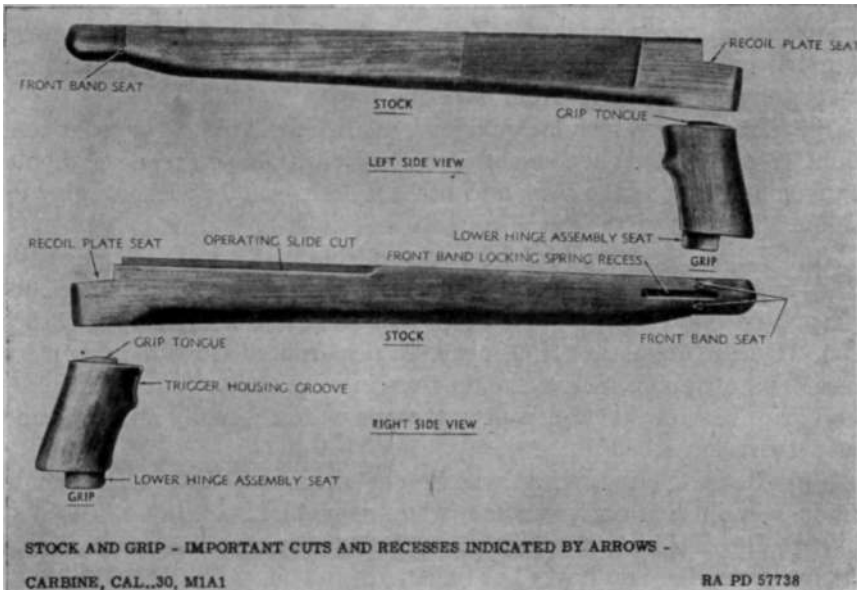

Figure 61. Stock and grip — carbine, cal. .30, M1A1.

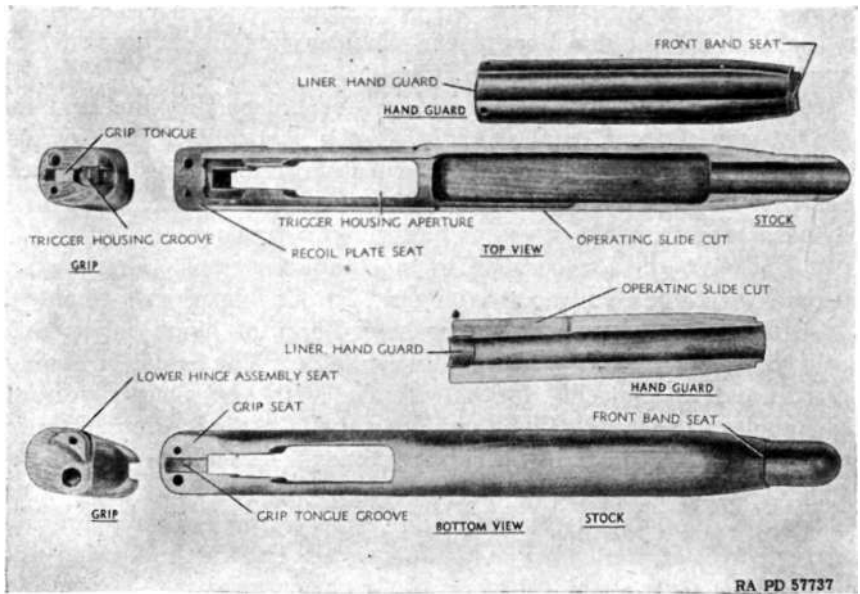

Figure 62. Stock, hand guard and grip — carbine, cal. .30, M1A1.

(4) Inspect recoil plate cap for dents and fit with rear end of stock. Plate should lie flush at the edges with the stock and receiver.

(5) Inspect recoil plate for security and level seating on stock. Plate should seat level and firm on stock, held down by grip screw passing through plate and stock and into routed threads in grip. When assembled, the grip screw holds all three parts together. The hinge screw, when assembled and threaded into the nut, binds the parts still tighter, and prevents the grip from twisting.

(6) Inspect receiver locking lug seat in recoil plate for wear and burrs. (See fig. 63.) When assembling, the locking lug on receiver should cam smoothly into the seat, and be held there snugly without play or shake.

(7) Inspect grip screw for length and burred threads. Replace the $2\frac{3}{32}$ -inch hinge screw by a $2\frac{3}{4}$ -inch screw. If screw has not been replaced, deepen grip screw hole to a total depth of 1.125 inches with a No. 21 drill (diameter 0.159 inch). Inspect routed threads in grip for wear and stripping. Screw should turn in snugly to retain recoil plate and grip. If screw is loose, routed threads will eventually strip out and grip twist loose.

(8) Inspect grip spring washer for deformation. Spacer should fit in hole in lock on lower bar, when assembled.

(9) Inspect hinge screw spacer for deformation. Spacer should fit in hole in lock on lower bar, when assembled.

(10) Inspect locking nut for looseness in lower hinge shell. Inspect shell for deformation. Inspect sling eyelet for looseness on hinge shell.

(See fig. 63.) (Nut is staked or spot-welded in shell, and eyelet spot-welded to shell.) Check locking slot in nut for wear and burrs (angle of slot face is 30°). Inspect lower hinge screw for wear and inspect threads in grip for stripping.

(11) Inspect hinge on upper bar for deformation and cracked welding, and lock on corresponding end of lower bar for deformation, cracked welding, and worn locking lug (fig. 58). The proper mating of lock and nut determine the rigidity of the stock extension when extended or folded. Angle of lock faces should correspond to that of the nut. Wear of lock or nut will cause improper locking and looseness.

(12) Inspect bars for deformation. They should lie in the same vertical plane when assembled.

(13) Inspect butt plate for smooth pivoting on rod ends, for spring action with spring assembled, and for cracks.

(14) Inspect butt plate spring for tension, excessive deformation, and broken or bent ends.

(15) Inspect cheek rest plate and retaining plate (fig. 58) for deformation and looseness with each other on the bars when assembled. Inspect rivets for looseness and protrusion of heads. Inspect cheek rest cover for scoring and cracking of leather. Cheek rest plate should be held tightly to rods by retaining plate and rivets, and leather cover should be smooth, so it will not scrape face of operator.

d. STOCK (M2). Inspect stock the same as for M1 and, in addition, examine clearance cut on right for disconnecter, and clearance cut on left for the selector. There must be no binding of the selector or disconnecter due to undersized cuts. (See fig. 64.)

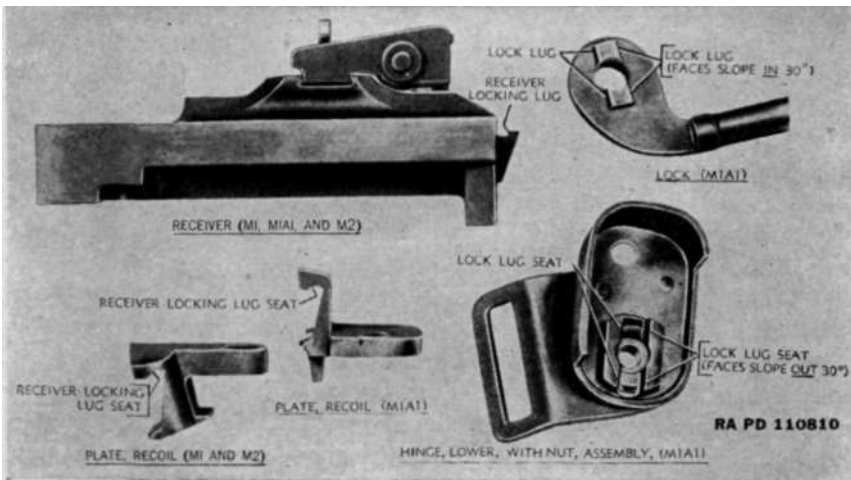

Figure 63. Important wearing surfaces.

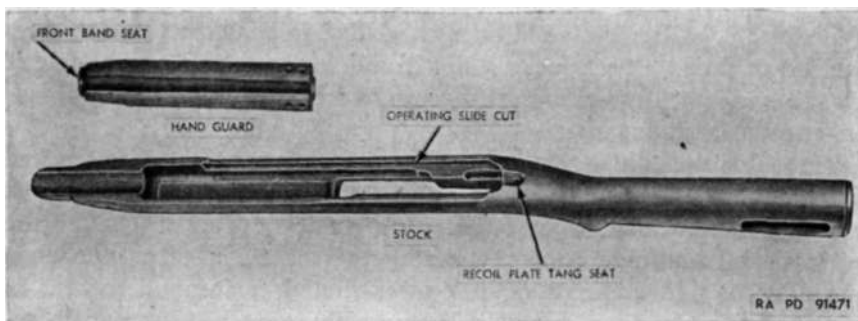

Figure 64. Stock and hand guard — carbine, cal. .30, M2.

56. Maintenance and Repair

a. BINDING OF PARTS WITH STOCK. (1) Binding of moving parts with stock or lack of proper clearance for assembly is evident on the stock by rubbed areas. Relieve such binding points by filing or paring, using fine file or sharp, flat blade.

(2) Relieve friction due to swelling caused by excessive moisture only enough to allow proper functioning and/or assembly, as wood may later dry out and shrink. Use of raw linseed oil will help to prevent undue swelling of wood due to excessive moisture.

(3) Points to check for excessive friction or lack of sufficient clearance are:

(*a*) Trigger housing aperture in stock. There must be a minimum of 0.010-inch clearance between stock and the rear of the trigger housing. Less than 0.010-inch clearance between stock and trigger housing causes the shock of recoil to be transmitted to the trigger housing retaining pin. This is especially detrimental in the case of the M2 carbine.

(*b*) Left inside face of stock opposite head of hammer pin when assembled. (Such scoring may be due to incorrectly assembled hammer pin.)

(*c*) Point on right side of stock and hand guard where operating slide bar passes through to right side of receiver.

(*d*) Recess in bed of stock in which operating slide functions.

(*e*) Forward shoulder of stock and hand guard, where front band seats.

(*f*) Left-hand side of stock where selector is located (M2 carbine).

(*g*) Right-hand side of stock where disconnecter lever assembly is located (M2 carbine).

b. LOOSE RIVETS IN HAND GUARD LINER. A loose hand guard liner indicates improper spreading of the rivets. These rivets are tubular; tighten them by spreading the hollow (inner) ends with a blunt punch. Support the opposite (beaded) end of the rivet while riveting. Place rivet head on a small steel rod or punch clamped in a vise.

c. FRONT BAND WILL NOT SEAT. If the front band will not seat properly behind the shoulder of the front band locking spring when assembled, the seating shoulders on stock or hand guard are not cut back far enough or the hand guard liner is too long. To remedy this condition, file the shoulders of stock or hand guard or both at the front sufficiently to allow proper seating and locking of band. Use a fine flat file with a safe edge, and file rear face of shoulder only. Do not file the hand guard liner, for if it is too short the hand guard will fly off when firing the carbine. (See par. 11*d*.)

d. PATCHING STOCKS. In most cases damaged or splintered stocks can be patched and reused. This must be accomplished by skilled workmen and is authorized in fifth echelon organizations only. (See fig. 19.) Wherever possible, dovetail patches in. The light-colored patches show areas that may be patched, and the approved method of inserting them in the stock. (See fig. 65.) The dark-colored patches show areas that cannot be patched without weakening the stock. Reinforce patches with special screws which are machined from brass. These are non-requisitionable and are to be made locally. Drill an 0.081-inch hole to receive screw. Install screw by gripping it in the chuck of a hand drill. (See fig. 66.) Cut off screw and file flush with stock. No edges must protrude.

57. Assembly

a. FRONT BAND LOCKING SPRING. Insert spindle of front band locking spring into hole in right forward end of stock and drive to the left. Seat spring fully in recess in stock.

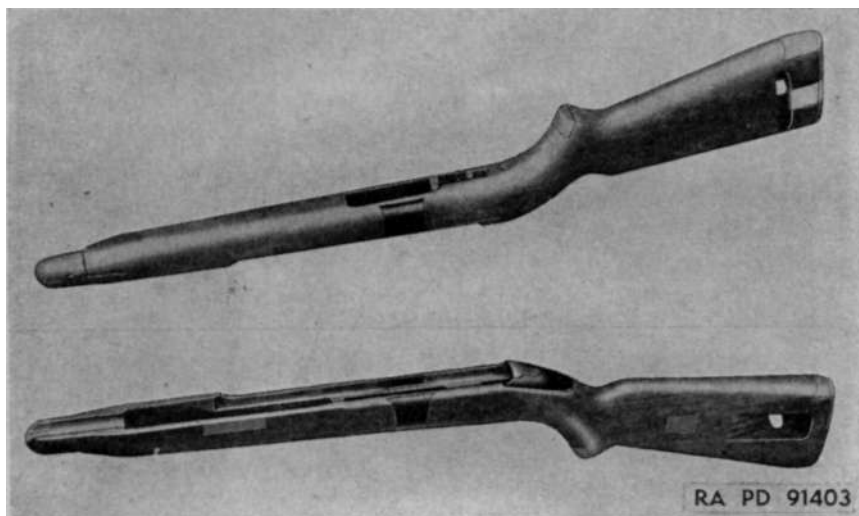
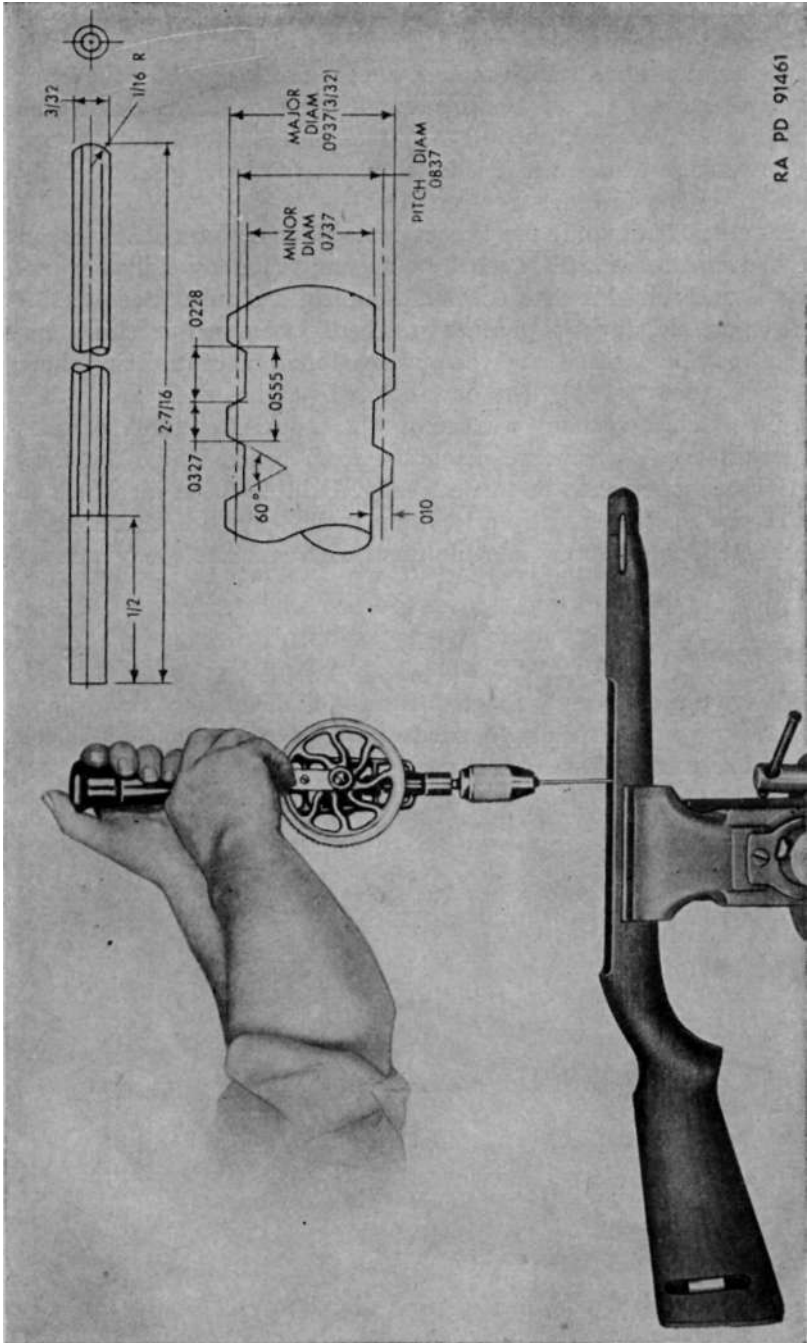

Figure 65. Patching stock — carbines, cal. .30, M1 and M2.



RA PD 91461

Figure 66. Installing reinforcing screws — carbines, cal. .30, M1 and M2.

b. RECOIL PLATE (EXCEPT M1A1.) (1) If escutcheon has been removed, insert small end first in seat in lower face of stock grip. Tap in until seated level and flush with stock.

(2) Insert recoil plate into rear of receiver aperture in stock with bevel face up and tang to rear. Recoil plate must be inserted from front to rear and held level during insertion, so that seating lug and horizontal recess mate. Seat recoil plate evenly and flush with recess in stock by tapping lightly. Replace recoil plate screw through top of recoil plate and stock grip, thread into escutcheon, and draw down part way. Then assemble barrel and receiver group to stock, align, and draw screw down tight. This prevents a strain on the parts (par. 11f).

c. BUTT PLATE (EXCEPT M1A1). Place butt plate on butt and tap lightly until solidly and evenly seated on butt. Insert screw and turn down snugly. Do not force screw as threads in wood of stock may strip.

d. STOCK EXTENSION (M1A1) (fig. 58). (1) If the grip and recoil plate have been removed, replace them by fitting grip to rear, under face of stock, just behind trigger guard opening so that projection on grip points downward and trigger guard bow will fit into forward face of grip when assembled. Then seat recoil plate on top of rear end of stock with undercut lug facing forward. Align screw holes in plate and stock, insert grip screw, and screw down tightly, turning clockwise, to secure recoil plate, stock, and grip firmly together.

(2) Place grip spring washer in large counterbored hole in lower end of grip and seat grip spring in hole upon washer. Then grasp stock extension so that locking lug on lower bar faces downward and place upper face of lock against lower end of grip spring. Hold in position firmly and press upward on lock against spring pressure until hinge on upper (straight) bar will slip over and lie upon top of recoil plate. Still holding lock in position with regard to spring, align hole in spring and lock, and insert hinge screw spacer until flush with lower face of lock.

(3) Position recoil plate cap over recoil plate and upper hinge so that it rests flat on hinge and recoil plate. Insert hinge screw through hole in cap and push downward through hinge, recoil plate, stock, grip, grip spring washer, grip spring, spacer, and lock on lower bar. Be sure screw is pushed down until upper shoulder on screw has entered the hole in upper hinge and is not bearing on cap, or top of hinge.

(4) Position lower hinge assembly over lock so that locking lug slot in nut mates with locking lug on lock, and sling eyelet faces forward. Then, press nut and lock upward against force of grip spring and turn hinge screw until threads on hinge screw catch threads in nut. (Be sure spacer is flush with lower face of lock before attempting to catch threads.) Turn screw so that nut pulls lower hinge upward until lower hinge shell is resting firmly upon lower face of grip.

(5) Insert lower hinge screw in lower end of stock grip and turn in

clockwise direction until tight. Then fold stock extension to left against stock to test locking. Stock extension should be locked rigidly when fully extended and when fully folded. Butt plate should turn on the rod ends to lie flat on stock when extension is folded. When extension is extended, butt plate should spring out and lie firmly in a plane at approximately right angles to the bore line. The perpendicular line of butt plate will be slightly to left of bore line when stock extension is extended. Be sure there is no movement between stock and grip.

SECTION XII

MAGAZINE ASSEMBLY

58. Disassembly

a. Grasp magazine in left hand with base up and rounded face toward the body. (See fig. 67.) With left thumb, press up on forward (rounded) end of magazine base until the base can be slid out of its retaining grooves in the base of body. Movement can be started by inserting rim of cartridge or point of screw driver in indent in top of base. Restrain magazine spring as base is removed, and withdraw from tube. (Bases of recent design are ribbed on the inside for stiffening, and have an overhanging lip on the round end. Such bases can be removed by inserting screw driver under lip and pulling up and out.)

b. Reverse tube, and slide follower to bottom of tube; then, grasp long rear flange of follower and rotate down out of tube.

c. If follower sticks in tube, insert screw driver or similar tool from top of tube to bear on rear end of follower and press on follower until stop flange is clear of tube. If flange will not rotate out, press up on opposite end to assist rotation. Do not force. Grasp flange and rotate follower out of tube.

d. Do not disassemble the magazine except for cleaning or salvage. Early type magazine tubes had a lip on the lower rear wall of the tube which often necessitated removal of the follower as in *c* above.

59. Inspection (figs. 68 and 69).

a. TUBE. Inspect lips of tube for deformation, dents, and burs. Inspect retaining lugs on rear face of tube for wear and burs, and base retaining flanges for deformation and retention of base. If lugs on rear face of tube are worn to the extent where proper retention is doubtful, scrap the magazine.

b. BASE. Inspect base for retention in tube, deformation, and worn retaining protrusion.

c. SPRING. Inspect spring for deformation, fracture, and set. Free length of spring is 5.30 ± 0.25 (approximately $5\frac{5}{16}$) inches.

60. Assembly

a. Insert short curved flange of follower into rear (flat side) of bottom opening of magazine tube and rotate long flange upward into tube.

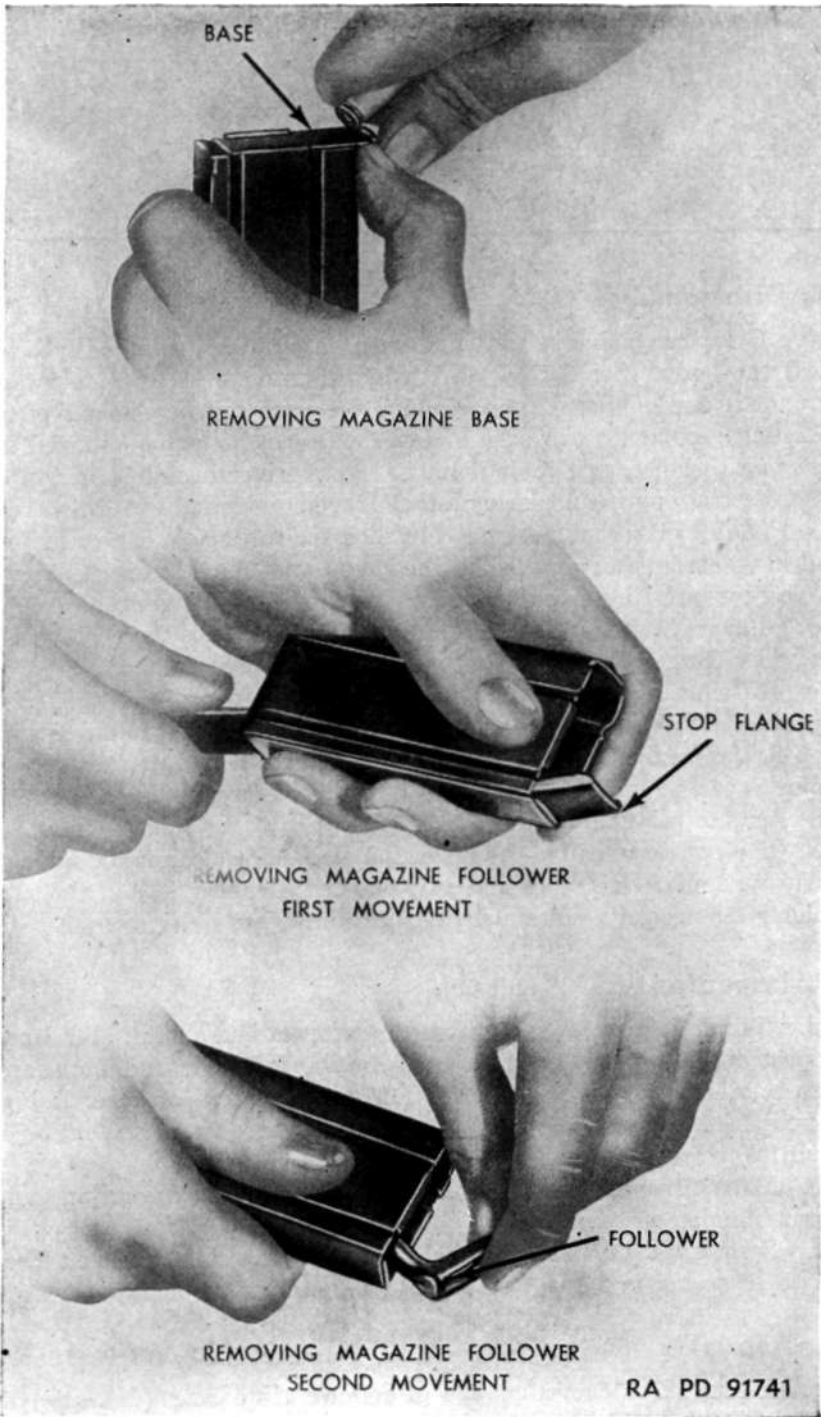

Figure 67. Removing magazine base and follower.

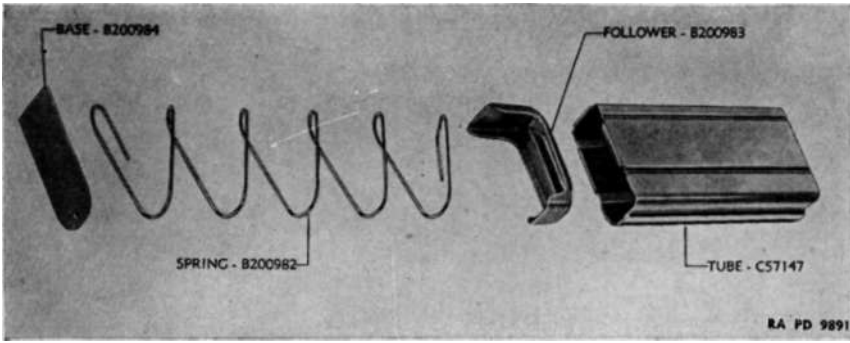

Figure 68. Magazine group.

b. If lip is present on tube, press down on opposite end of follower and rotate, until end of long flange snaps under lip of tube. If necessary, insert screw driver or similar tool into top of tube to hold short end and assist in rotation. Do not force unduly or magazine will be distorted. (Recent design follower rotates easily into tube.)

c. Push follower to top of tube and insert magazine spring with long dimension to the rear as shown in figure 68. In this position the follower will slide evenly in the tube. Compress spring with thumb, and starting from the rounded edge of tube, insert the base, square end first, with projection of indent facing in, under retaining lips of tube. Push base in until projection catches on tube. Push follower down in tube and release to test smoothness of functioning. If follower does not reciprocate smoothly under spring action, tube or follower is distorted and should be corrected. (Magazine base of recent design is ribbed for stiffening. Ribs should face inward when base is assembled.)

d. When assembled correctly, the ramp on the follower must be facing the rear of the tube. The rear of the magazine tube is flat and has the two nibs for engaging the magazine catch. (See fig. 70.)

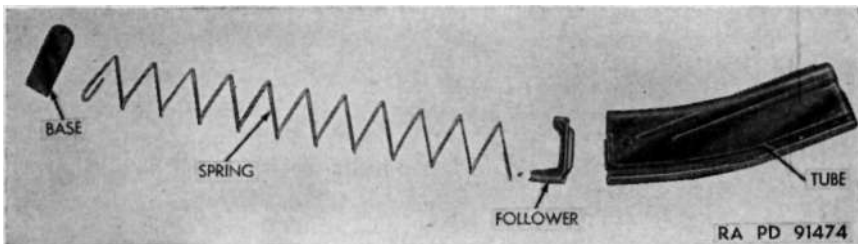

Figure 69. Magazine — 30-round — disassembled.

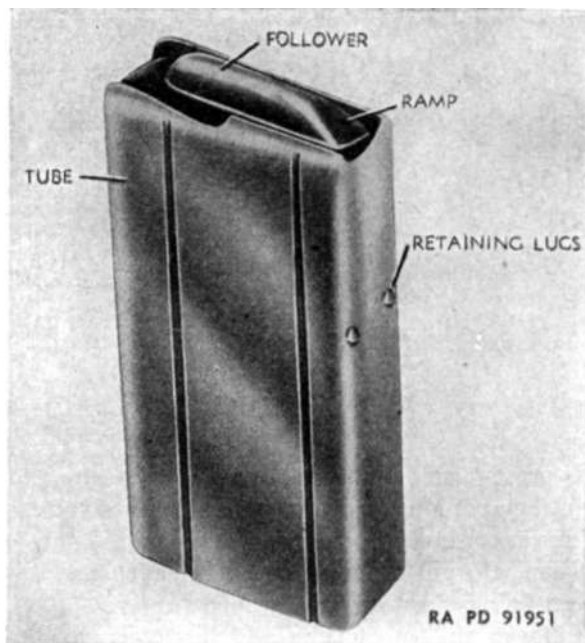

Figure 70. Follower properly assembled.

SECTION XIII

EQUIPMENT

61. Sling (M1, M1A1, and M2)

Make the following inspections:

- a.* Sling for cuts, wear, and serious blemishes.
- b.* Metal tips for fracture, deformation, and looseness on webbing of sling.
- c.* "Lift-a-dot" fastener for looseness in sling, wear, corrosion, and positive retention with mating eyelet. Fastener should snap to locked position and hold firmly.
- d.* Check buckle for deformation, fracture, and corrosion.

62. Oiler (except M1A1)

Make the following inspections:

- a.* Oiler for dents and corrosion.
- b.* Oiler cap for loose or uneven fit on tube and for oil leakage.
- c.* Tube and cap for worn or burred threads.
- d.* Rod (dropper) for deformation and looseness in cap.
- e.* Position of oiler tube ring in tube, and washer on ring.
- f.* Wear.

63. M4 Bayonet Knife

a. Make the following inspections:

- (1) The bayonet as a unit for appearance and general condition, fit and retention on carbine, and looseness of components.
 - (2) Blade for deformation, broken or nicked point, nicked or burred blade edge, and dullness.
 - (3) Guard for deformation, deformed or dented barrel band, loose fit on barrel, looseness on the blade, and burs.
 - (4) Bayonet catches for wear, free action, deformation, looseness, and burs.
 - (5) Bayonet finish. If bayonet must be refinished, care must be taken not to dip the leather handle into the finishing tanks.
- b.* After inspection, the bayonet should be wiped dry and oiled with a slightly oiled cloth.

64. M8A1 Scabbard

Make the following inspections:

- a.* Scabbard as a unit for appearance, general condition, fit and retention of the bayonet, ease of bayonet withdrawal, and looseness of components.
- b.* Body for cuts, deep abrasions, or splitting.
- c.* Mouthpiece top for looseness on the body and for wear and burs.
- d.* Hook for deformation, wear, and burs.

SECTION XIV

FUNCTION FIRING AND FINAL INSPECTION

65. General

Weapons turned in for repair may be assumed to have defects caused by use or neglect. When they were accepted as new weapons, the parts composing them were dimensionally correct and made of the proper material. Consequently the inspection of these weapons after repair will differ from the inspection procedure used in the manufacturing plant in that attention will be directed to wearing surfaces, parts that might crack or break due to high stress or fatigue, and evidence of corrosion. These defects do not evidence themselves by uniform reduction in a given dimension but show up as a chipped edge, a partially worn surface, or an eccentric hole. A gauge used in manufacturing is merely means of comparing an unknown dimension with a known one to judge whether a piece comes within tolerances. After a piece is worn through use, the change in dimension is more easily detected in many cases by comparing with adjacent surfaces; the piece in itself becomes a gauge. Visual inspection, therefore, is far more applicable in these cases and gauging is limited to those dimensions that are critical and that may be advantageously measured rather than compared. Inspection of noncritical parts (parts that do not cause malfunctions) is limited to appearance and the presence of cracks or flaws. The dimensions placed on these parts (and gauging used during manufacturing) were for the sole purpose of insuring interchangeability. Even if the dimensions of such parts are worn considerably below drawing tolerances, functioning and interchangeability will not be adversely affected and the parts are consequently acceptable.

66. Function Firing

Function fire each weapon following complete overhaul, using one complete magazine (15 rounds) of standard service ball ammunition. Fire the M1 and M1A1 carbines from a buck or from the shoulder. The 15 rounds must be fired without malfunction, for acceptance of the gun. Should a malfunction occur, fire an additional two full magazine (30 rounds) without malfunction for acceptance of the weapon. Correct guns which fail to meet function firing by such

component replacement or armorers operations required. Subject these guns again to the 30-round function firing test which must be met for acceptance of the gun. Where malfunctions may be attributed to faulty magazine or ammunition, conduct additional function firing with magazine or ammunition of known satisfactory quality. Function fire the M2 carbine, using 15 rounds for semiautomatic and 15 rounds full automatic. In case of malfunction follow the same procedure outlined above. After function firing clean the weapons thoroughly in the prescribed manner to prevent corrosion. Be sure to scrub the bolt face, the arch around the chamber face, the piston face and surrounding arch, the inside face of the operating slide, and the bore.

67. Final Inspection

a. For depot storage over-all appearance is approximately that of a new weapon.

b. All exposed metal surfaces must have a dull, rust-resistant finish with no burs, deep scratches, or tool marks.

c. Moving parts and bearing surfaces must not be burred or rusty.

d. Barrels must be straight, clean of rust and powder fouling, and free from bulges. Fine pits are allowable if they do not materially affect the sharpness of lands. Pits in the chamber are allowed if they are not sufficiently large to cause extraction difficulties.

e. Dents and mutilations in woodwork that do not affect serviceability must be sanded over and treated with linseed oil.

f. Weapons must be complete with all necessary accessories, the current applicable modifications, and instructions in current Technical Bulletins followed. The serial number must be legible.

g. All parts must be properly aligned and have specified clearance.

h. Visual inspection:

(1) General appearance, smoothness of operation, and function. Test with magazine of dummy cartridges.

(2) Magazine for play and function.

(3) Stock and hand guard for cracks and mutilation.

(4) M2 carbine for new full round bolt.

(5) Swivels and screws for proper staking.

(6) Front band for loose rivets.

(7) Front sight for looseness and bent or burred wings.

(8) Rear sight for following:

(*a.*) Binding of windage screw.

(*b.*) Rear sight aperture slide for free movement and positive position or various elevations.

(9) Trigger housing group for the following:

(*a.*) Bent trigger guard.

(*b.*) Looseness of trigger housing when assembled to receiver.

(*c.*) Looseness between recoil plate and receiver.

- (d) Function of selector on M2 carbine.
- (e) Function of safety, trigger, sear, and hammer.
- (f) Function of magazine catch. See that catch (7160470) is installed.

i. FUNCTION AND INSPECTION WITH GAUGES. (1) Operate by hand to ascertain that final adjustments have been made to assure proper operation.

(2) Test trigger pull (minimum 5 pounds; maximum 7 pounds)

(3) When inspecting the bolt, gauge the firing pin protrusion. The minimum should be 0.048 inch and the maximum should be 0.065 inch. Note shape and condition of firing pin point.

(4) Inspect for headspace. Refer to serviceability chart (fig. 19).

(5) Inspect bore and chamber.

(6) Assemble and function test with dummy cartridges.

j. INITIAL. This applies to arsenals only. No marking required by other echelons. If passed, arsenal will stamp weapon with appropriate arsenal and inspector's initials. No marking is required in third and fourth echelons.

APPENDIX

REFERENCES

1. Publication Indexes

The following publication indexes should be consulted for the latest changes or revisions of references and for new publications relating to materiel covered in this manual.

Ordnance Supply Catalog, Introduction	WD Cat. ORD 1
Ordnance Supply Catalog, Index	WD Cat. ORD 2
List and index of War Department Publications	FM 21-6
List of War Department films, film strips, and recognition film slides	FM 21-7
Military Training Aids	FM 21-8

2. Standard Nomenclature Lists

Tools, maintenance, for repair of small and hand arms, and pyrotechnic projectors.	ORD 6 SNL B-20
Carbine, Cal. .30, M1 and M1A1, M1A3, M2	SNL B-28
Fire control major items and major combinations for use with small arms, automatic guns, trench mortars, and field artillery.	ORD 3 SNL F-1
Truck, 2 ¹ / ₂ ton, 6 x 6, small arms repair, M7A1 and M7A2	ORD G-138
Cleaning, preserving and lubricating materials; recoil fluids, special oils, and miscellaneous related items	ORD 3 SNL K-1
Soldering, brazing and welding materials, gases and related items	ORD 3 SNL K-2
Small arms targets and target equipment.	ORD 3 SNL L-1
Ammunition, rifle, carbine, and automatic gun.	ORD 11 SNL T-1
Miscellaneous service components of small-arms, ammunition for Field Service Account, instruction material, and ammunition for simulated small-arms fire	ORD 11 SNL T-4

3. Explanatory Publications

Range regulations for firing ammunition for training and target practice	AR 750-10
--	-----------

Ordnance Service in the Field	FM 9-5
Ordnance Field Maintenance	FM 9-10
Defense Against Chemical Attack	FM 21-40
U. S. Carbine, Cal. .30, M1 and M1A1	FM 23-7
Introduction to Ordnance Storage and Ship- ment Charts	IOSSC(a)
Ordnance Storage and Shipment Charts — Group B - major	SB9-OSSC-B
Decontamination	TM 3-220
Sniperscope, M2	TM 5-9341
Cleaning, Preserving, Sealing, Lubricating, and Related Materials Issued for Ordnance Materiel	TM 9-850
Small Arms Ammunition	TM 9-1990

★ U. S. GOVERNMENT PRINTING OFFICE, 1947—06394—95

